

Black Widow Optimization Algorithm: A novel meta-heuristic approach for solving engineering optimization problems[☆]

Vahideh Hayyolalam, Ali Asghar Pourhaji Kazem^{*}

Department of Computer Engineering, Tabriz Branch, Islamic Azad University, Tabriz, Iran

ARTICLE INFO

Keywords:

Black Widow Optimization Algorithm (BWO)
Bio-inspired algorithm
Nonlinear optimization
Combinatorial optimization
Engineering applications

ABSTRACT

Nature-inspired optimization algorithms can solve different engineering and scientific problems owing to their easiness and flexibility. There is no need for structural modifications of optimization problems to apply meta-heuristic algorithms on them. Recently, meta-heuristic algorithms are becoming powerful methods for solving NP problems. In this paper, the authors propose a novel meta-heuristic algorithm suitable for continuous nonlinear optimization problems. The proposed method, Black Widow Optimization Algorithm (BWO), is inspired by the unique mating behavior of black widow spiders. This method includes an exclusive stage, namely, cannibalism. Due to this stage, species with inappropriate fitness are omitted from the circle, thus leading to early convergence. BWO algorithm is evaluated on 51 various benchmark functions to verify its efficiency in obtaining the optimal solutions for the problems. The obtained results indicate that the proposed algorithm has numerous advantages in different aspects such as early convergence and achieving optimized fitness value compared to other algorithms. Also, it has the capability of providing competitive and promising results. The research also solves three different challenging engineering design problems adopting BWO algorithm. The outcomes of the real case study problems prove the effectiveness of the proposed algorithm in solving real-world issues with unknown and challenging spaces.

1. Introduction

Recently, due to the high complexity of real-world problems, the need for efficient meta-heuristic methods emerges. Metaheuristic methods on account of their high efficiency and easy implementation become extremely popular. These methods are adopted for solving NP problems, real-world engineering issues, and obtaining the potential optimal solutions for them in a given time (Kumar et al., 2014). The popularity of these algorithms is not limited to the computer or other engineering domains; they also are applied to economics, holiday planning, and more other issues. Having the ability to escape from local optima, the application of meta-heuristic algorithms can be seen in various fields of industry and science.

Meta-heuristic techniques are categorized into three groups, including physical-based, swarm-based, and evolutionary-based methods. The basic inspiration of the physical-based algorithms is physics rules such as electromagnetic force, inertia force, gravitational force, and so forth. Considering these rules, the search agents of the algorithms communicate and move through the search space. Some algorithms such as Gravitational Search Algorithm (GSA) (Rashedi et al., 2009),

Simulated Annealing (SA) (Kirkpatrick et al., 1983), Big-Bang Big-Crunch (BBBC) (Erol and Eksin, 2006), Charged System Search (CSS) (Kaveh and Talatahari, 2010a), Galaxy-based Search Algorithm (GbSA) (Shah-Hosseini, 2011), and Black Hole (BH) (Hatamlou, 2013) algorithm are considered in this group. The algorithms in the second group, swarm-based, are inspired by the collective manner of social beings, which refers to the way of interaction among the members of a swarm and their environment. Particle Swarm Optimization (PSO) (Poli et al., 2007), Wolf pack search algorithm (Yang et al., 2007), Bee Collecting Pollen Algorithm (BCPA) (Lu and Zhou, 2008), Dolphin Partner Optimization (DPO) (Shiqin et al., 2009), Cuckoo Search (CS) (Yang and Deb, 2009), Firefly Algorithm (FA) (Yang, 2010a), Ant Colony Optimization (Dorigo et al., 1996) are some of the well-known algorithms of this group.

The algorithms in the last group are mostly inspired by the nature and biological evolution like selection, reproduction, combination, and mutation. These algorithms are derived from the natural selection theory of Darwin, which is defined as descent with modification, the idea of changing species over time and generation of new ones (Beddall, 1968). In the process of natural selection, the main heritable traits,

[☆] No author associated with this paper has disclosed any potential or pertinent conflicts which may be perceived to have impending conflict with this work. For full disclosure statements refer to <https://doi.org/10.1016/j.engappai.2019.103249>.

^{*} Corresponding author.

E-mail addresses: p.hayyolalam@gmail.com (V. Hayyolalam), a.pourhajikazem@iaut.ac.ir (A.A. Pourhaji Kazem).

aiding species to survive and reproduce, become more common in a population gradually. Almost all of the evolutionary algorithms have been inspired by the natural selection theory. However, these methods have some differences in the expression of this theory. These differences are owing to the fact that each of the algorithms mimics a distinct creature or habits of the individuals to evolve and generate new descendants. In evolutionary algorithms, a population of possible solutions attempts to survive with regards to the fitness assessment in a specific environment. These algorithms randomly accomplish the optimization process. The initial population of the process of optimization is created randomly and then modified by predefined operations over a definite number of generations or iterations. The central structure of almost all of the population-based algorithms is like this. The distinct mechanisms of reproducing, moving, and developing the solutions throughout the optimization process, make these algorithms differ from each other. One of the most important evolutionary-based algorithms is Genetic Algorithm (GA) (Holland, 1975). As a matter of fact, majority of the evolutionary algorithms or population-based algorithms resemble GA; thus, some researchers call these algorithms as Genetic-type algorithms. Evolution Strategy (ES) (Beyer and Schwefel, 2002), Forest optimization algorithm (Ghaemi and Feizi-Derakhshi, 2014), and so forth are considered in this group of algorithms.

By and large, most of the population-based algorithms, free from the structure of the algorithm, illustrate a common characteristic in the searching procedure with regards to the exploration and exploitation stages which are two vital features of an algorithm. In order to obtain high efficiency, meta-heuristic algorithms should keep the balance between exploration and exploitation stages of the search space. The exploration phase provides an opportunity for the algorithm to inspect various potential areas of the search space and produce new solutions to escape from the local optima problem (Lin and Gen, 2009). The exploitation refers to the convergence capability of an algorithm nearby the achieved expected solutions in the exploration stage. Therefore, a good performance in exploration and exploitation guarantees evade of local optima and good convergence, respectively. Additionally, an appropriate balance of these two stages can ensure reaching the global optima. Although there is a remarkable number of meta-heuristic algorithms, still new algorithms are required. With regards to the fact that there is not any particular algorithm to obtain the best solution for almost all optimization problems as No-Free-Lunch (NFL) (Wolpert et al., 1997) claims, innovating of novel meta-heuristic optimization algorithms is still an open issue.

During the past few years, Nature-inspired algorithms have been experiencing extremely breakthrough in the industrial world, where they have been proven to be very useful in solving real-world optimization problems (Alami and Imrani, 2008). In this paper, we intend to introduce a novel population-based optimization algorithm entitled Black Widow Optimization Algorithm (BWO), which is inspired by the lifecycle of black widow spiders. The bizarre mating behavior of black widows shapes the fundamentals of this algorithm. This paper illustrates how the lifecycle of black widows is modeled and implemented.

Briefly speaking, this research introduces a new metaheuristic optimization algorithm entitled Black Widow Optimization (BWO) which imitates the strange mating behavior of the black widow spiders. The proposed method has various main differences compared to other methods. Providing a good performance in exploitation and exploration stages, the BWO algorithm delivers fast convergence speed and avoids local optima problem. Moreover, it should be mentioned that BWO has the ability to maintain the balance between exploitation and exploration. In other words, it is able to inspect a large area to obtain the best global solution; hence, BWO will be a good choice for solving different optimization problems with several local optima. The efficiency of the proposed BWO algorithm is assessed by solving 51 benchmark functions and three real-world engineering optimization problems. The obtained results prove the superiority of the proposed algorithm in comparison

with several other meta-heuristic algorithms such as GA, PSO, ABC, BBO, ALO (Mirjalili, 2015b), MFO (Mirjalili, 2015a), GWO (Mirjalili, Mirjalili, and Lewis 2014), WOA (Mirjalili and Lewis, 2016), SHO (Dhiman and Kumar, 2017), MVO (Mirjalili et al., 2016), and HS (Geem et al., 2001). Briefly, the essential contribution of this paper is like the following lines:

1. A novel population-based optimization algorithm entitled BWO which imitates the strange mating behavior of the black widow spiders was introduced.
2. Several tests are conducted over 51 benchmark functions and three engineering optimization problems that are adopted for assessing the effectiveness of the proposed algorithm. The experimental results ensure that the BWO algorithm is efficient enough in solving complex optimization problems.
3. The proposed BWO algorithm is able to escape from local optima problem and keep the balance between the exploitation and exploration stages in comparison with other investigated algorithms

The rest of this paper is organized as follows: Section 2 investigates the spiders called black widow and reviews their peculiar lifecycle. In Section 3, the Black Widow Optimization Algorithm (BWO) is proposed. The proposed algorithm is tested with some benchmark functions in Section 4. Three classical engineering design problems are solved using the proposed algorithm in Section 5. In Section 6, the discussion of the research is pointed out, and finally, the conclusion is shown in Section 7.

2. Black widow spiders (*Latrodectus hasselti*) and their lifestyle

Spiders (order Araneae) are air-breathing arthropods, which have eight legs and [chelicerae] with venomous fangs. Among all orders of organisms, these species are the largest order of arachnids, and they rank seventh in total species diversity (Sebastian and Peter, 2009). As of November 2015, taxonomists have recorded approximately 45,700 spider species and 114 families. However, dissension has been arisen within the scientists as to how all these families should be classified, more than 20 various taxonomies that have been suggested since 1900 (Foelix, 1996). The spider subfamily *Latrodectus* comprises the renowned black widows, infamous due to the excessive potency of their neurotoxic venom (Andrade, 2003). The subfamily has a general distribution all over the world and consists of 30 species, which have been recognized up to now. *Latrodectus* contains a suite of species popularly known as black widow spiders, mostly known by the red "hour-glass" sign upon their abdomen, as well as the Australian red-back spider (Forster, 1995) and the cosmopolitan brown widow (Garb et al., 2004).

2.1. A brief description of black widows' lifestyle

The Black widow is mostly nightly, and the female one remains out of sight during the day, and during the night, she spins her web. Generally, the female widow lives in the same site for most of her adult life (Andrade and Banta, 2002). Whenever the female black widow desires to mate, she marks certain spots of her net with pheromone to attract the male (Birkhead and Møller, 1998). The first male entering the web renders females' web-less attractive to rivals by web reduction (Scott et al., 2015; Watson, 1986). The female consumes the male during or post-mating, then she transfers eggs to her egg sock. After hatching the egg, the offspring engages in sibling cannibalism (Andrade, 1998; Berning et al., 2012; Elgar and Nash, 1988; Forster, 1992; Fox, 1975; Gage, 2005; Gaskett, 2007; Jayaweera et al., 2015; Modanu et al., 2014; Perampaladas et al., 2008; Watson, 1986; Wikipedia, 2016). However, they stay on their mothers' web for a short period in which they might even consume the mother (ENGELHAUPT, 0000). This cycle causes survival of the fit and strong individuals. The best one is the global optimum of the objective function. Fig. 1 (Wikipedia, 0000) shows a female Black Widow on her web and also Fig. 2 (Wikipedia, 0000) indicates a female Black Widow with her egg sac on her web.



Fig. 1. Female black widow on her web.



Fig. 2. Female black widow in her web with egg sac.

2.2. Reproduction style and cannibalism

Sexual cannibalism in which a female eats a conspecific male before, during or immediately after mating (Elgar and Nash, 1988), is a fascinating behavior exhibited most commonly in invertebrates such as spiders, scorpions and praying mantis (Andrade and Banta, 2002). Several female aspects such as body condition, mating status, and orientation are predicted to impact the likelihood of cannibalism, and males are expected to respond to these factors by amending their approach behaviors in ways that minimize the chance of being attacked (Jayaweera et al., 2015).

The Black widow spider is one of the only two known animals to which the male actively plays an assistant role and helps the female in sexual cannibalism (McKeown, 1963). In about two of three cases of the mating process, the female wholly eats the male while mating continues (Perampaladas et al., 2008). Males who are not consumed die of their injuries in a little while after mating (Forster, 1992). It seems that the sacrifice during mating has conferred the chance of fertilization of more eggs (Andrade, 1996).

A female black widow may lay 4 to 10 egg sacs (Gray, 0000), each of which contains averagely around 250 eggs (Australian Museum, 0000), though can be as few as 40 or as many as 500 (Gray, 0000).



Fig. 3. Baby spiders leave their egg sac.

2.3. Sibling cannibalism

Spiderlings hatch from their eggs after almost eight days and also in 11 days after being laid, they can emerge from the egg sac, although cooler temperatures can significantly slow their development so that emergence does not happen for months (Downes, 1986). They spend near a week inside the egg sac after hatching and feeding on the yolk and molting once (Modanu et al., 2014). Black widow spiderlings live together on the maternal web (Fig. 3) for several days to a week, during which time sibling cannibalism is mostly observed (Modanu et al., 2014). They then leave by being carried on the wind (Andrade, 1998).

Several factors cause cannibalistic behavior, from among which being competition among predatory conspecifics and also the potential for the other possible food source in the lack of prey availability periods, are the most obvious ones (Mock and Ploger, 1987). Both of these factors considerably increase in high-density populations. Thus cannibalism is frequently linked to demography and can have significant population-level effects (Schausberger and Hoffmann, 2008). Population size can be controlled by density-dependent cannibalism and may be important in black widow spider populations (reviewed in Fox, 1975; Perry and Roitberg, 2005).

One of the well-documented special cases of cannibalism is sibling consumption (Guimaraes et al., 2012), but reasons and results are still not well understood (Baur, 1988). Like other types of cannibalism, sibling cannibalism can affect the population-level, but with appended implications for the general fitness of the cannibal and its parents (Baur, 1988; Petersen et al., 2010; Simon, 2008) and these implications may be different for various behavioral type to another (Berning et al., 2012). In some cases, consuming a sibling can rise parental fitness, and the happening of these behaviors is controlled by parents (Mock and Ploger, 1987; Schausberger and Hoffmann, 2008).

The precise outcome of unselective sibling cannibalism on parental fitness may affect the development of parental procreative strategies (Perry and Roitberg, 2005). The cannibalism reduces the number of surviving spiderlings; however, it may rise parental fitness as well if survivors have enhanced body condition (Guimaraes et al., 2012). If sibling cannibalism like other forms follows the same patterns, so the rates of cannibalism would rise with the number of siblings (Baur, 1988), especially if the possible cannibal is in bad condition (Petersen et al., 2010). Moreover, in some cases, unfertilized spiderlings eat, their mother very slowly. During some weeks, she is eaten away until she falls immobile and is consumed entirely. Spiderlings generally perform very well in cases of matrophagy, with higher weights and survival rates than young that do not consume their mom (ENGELHAUPT, 0000).

3. The proposed black widow optimization algorithm

Fig. 4 shows the flowchart of the proposed algorithm. Like other evolutionary algorithms, the proposed algorithm starts with an initial

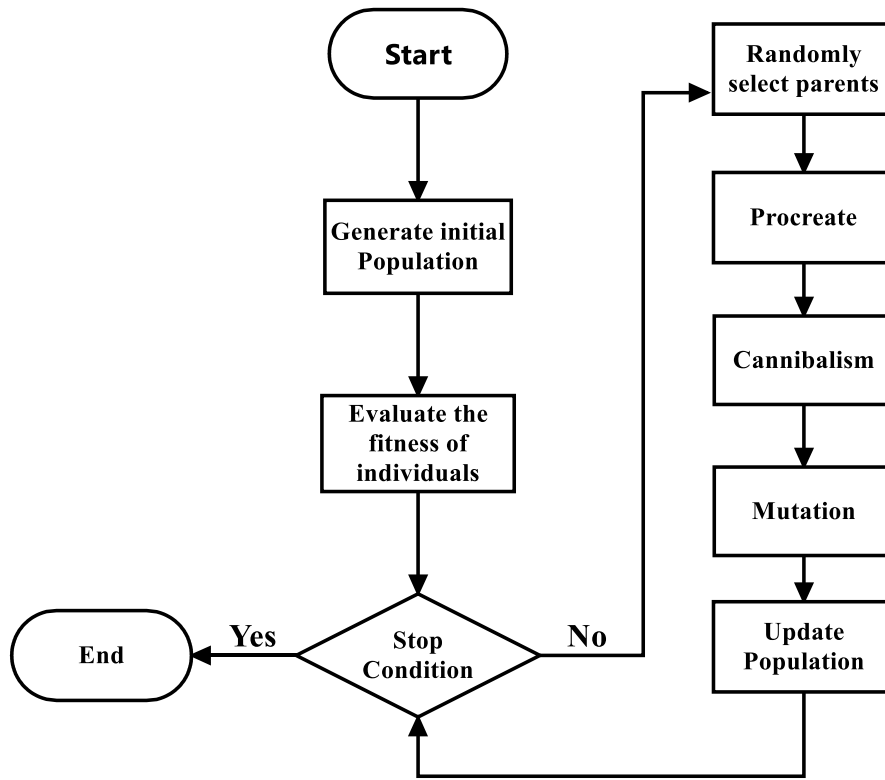

Fig. 4. Flowchart of the black widow optimization algorithm.

population of spiders, so that each spider represents a potential solution. These initial spiders, in pairs, try to reproduce the new generation. Female black widow eats the male during or after mating. Then she carries stored sperms in her sperm thecae and releases them into egg sacs. As early as 11 days after being laid, spiderlings come out of the egg sacs. They cohabit on the maternal web for several days to a week, during which time sibling cannibalism is observed. They then leave by being carried on the wind.

3.1. Initial population

In order to solve an optimization problem, the values of problem variables must form as an appropriate structure for the solution of the current issue. In GA and PSO terminologies, this structure is called “Chromosome” and “Particle position”, respectively, but here in black widow optimization algorithm (BWO) it is called “widow”. In Black widow Optimization Algorithm (BWO), the potential solution to each problem has been considered as a Black widow spider. Each Black widow spider shows the values of the problem variables. In this paper, in order to solve benchmark functions, the structure should be considered as an array.

In a N_{var} -dimensional optimization problem, a widow is an array of $1 \times N_{\text{var}}$ representing the solution of the problem. This array is defined as follows:

$$\text{Widow} = [x_1, x_2, \dots, x_{N_{\text{var}}}]$$

Each of the variable values $(x_1, x_2, \dots, x_{N_{\text{var}}})$ is floating-point number. The fitness of widow is obtained by evaluation of fitness function f at a widow of $(x_1, x_2, \dots, x_{N_{\text{var}}})$. So

$$\text{Fitness} = f(\text{widow}) = f(x_1, x_2, \dots, x_{N_{\text{var}}})$$

To start the optimization algorithm, a candidate widow matrix of size $N_{\text{pop}} \times N_{\text{var}}$ is generated with an initial population of spiders. Then pairs of parents randomly are selected to perform the procreating step by mating, in which the male black widow is eaten by the female during or after that.

3.2. Procreate

Since the pairs are independent of each other, they start to mate in order to reproduce the new generation, in parallel, as well in nature, each pair mate in its web, separately from the others. In real-world, approximately 1000 eggs are produced in each mating, but finally, some of the spider babies are survived, which are stronger. Now, here in this algorithm in order to reproduce, an array called alpha should also be created as long as widow array with random numbers containing, then offspring is produced by using α with the following equation (equation1) in which x_1 and x_2 are parents, y_1 and y_2 are offspring.

$$\begin{cases} y_1 = \alpha \times x_1 + (1 - \alpha) \times x_2 \\ y_2 = \alpha \times x_2 + (1 - \alpha) \times x_1 \end{cases} \quad (1)$$

This process is repeated for $N_{\text{var}}/2$ times, while randomly selected numbers should not be duplicated. Finally, the children and mom are added to an array and sorted by their fitness value, now according to cannibalism rating, some of the best individuals are added to the newly generated population. These steps apply to all pairs.

3.3. Cannibalism

Here we have three kinds of cannibalism. The first one is sexual cannibalism, in which the female black widow eats her husband during or after mating. In this algorithm, we could recognize female and male by their fitness values.

Another kind is sibling cannibalism in which the strong spiderlings eat their weaker siblings. In this algorithm, we set a cannibalism rating (CR) according to which the number of survivors is determined. In some cases, the third kind of cannibalism is often observed in which the baby spiders eat their mother. We use the fitness value to determine strong or weak spiderlings.

<i>Pseudo Code of Black Widow Optimization algorithm</i>
Input: Maximum number of iteration, Rate of procreating, rate of cannibalism, rate of mutation
Output: near-optimal solution for the objective function
<pre> // initialization 1. The initial population of black widow spiders Each pop is a D-dimensional array of chromosomes for a D-dimensional problem // Loop until the terminal condition 1. Based on procreating rate , calculation the number of reproduction “ nr ” ; 2. Select the best nr solutions in pop and save them in pop1 ; // Procreating and cannibalism 3. For i=1 to nr do 4. Randomly select two solutions as parents from pop1 ; 5. Generate D children using equation1 ; 6. Destroy father ; 7. Based on the cannibalism rate, destroy some of the children (new achieved solutions) ; 8. Save the remain solutions into pop2 ; 9. End for // Mutation 10. Based on the mutation rate, calculate the number of mutation children “ nm ” ; 11. For i=1 to nm do 12. Select a solution from pop1 ; 13. Mutate randomly one chromosome of the solution and generate a new solution ; 14. Save the new one into pop3 ; 15. End for // Updating 16. Update pop = pop2+pop3 ; 17. Returning the best solution ; 18. Return the best solution from pop ; </pre>

Fig. 5. Pseudo code of black widow optimization algorithm.

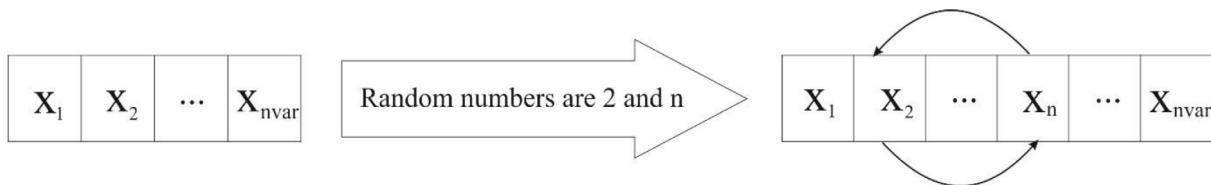

Fig. 6. Mutation.

3.4. Mutation

In this stage, we randomly select Mutepop number of individuals from population. As Fig. 6 illustrates, each of the chosen solutions randomly exchanges two elements in the array. Mutepop is calculated by the mutation rate.

3.5. Convergence

Like other evolutionary algorithms, three stop conditions can be considered: (a) a predefined number of iterations. (B) Observance of no change in the fitness value of the best widow for several iterations. (C) Reaching to the specified level of accuracy.

The main stages of BWO are summarized in a pseudo-code shown in Fig. 5. In the next section, BWO will be applied to some benchmark optimization problems. As optimal solutions are known for benchmark functions in advanced, so reaching a specified level of accuracy is considered as determination of accuracy level for the experimental algorithms. Also, the maximum number of iteration is set as a stop condition in the experiments of Section 4.

3.6. Parameter setting

In the proposed BWO algorithm, there are some parameters which are essential for obtaining better results. These parameters include procreating rate (PP), cannibalism rate (CR), and mutation rate (PM). The selected values for these parameters in this paper are shown in Table 2. The parameters should be appropriately adjusted to improve the successfulness of the algorithm in finding superior solutions. The better tuning the amount of the parameters, the higher the chance for jumping out of any local optimum and higher ability to explore the search space globally as well. Hence, the right amount of parameters can ensure the controlling of the balance between exploitation and exploration stages. The proposed algorithm equipped with three vital controlling parameters, including PP, CR, and PM. PP is the percentage of procreating, which determines how many individuals should be participated in procreate. This parameter by controlling the production of various offspring provides further diversification and gives more opportunity to explore the search space more precisely. CR is the controlling parameter of the cannibalism operator, which omits the inappropriate individuals from the population. Adjusting the proper value for this parameter can ensure high performance for the exploitation stage by transferring the search agents from local to the global stage and vice versa. PM is the percentage of the individuals participating in mutation. Right value for this parameter can ensure the balance between exploitation and exploration stage. This parameter can control the transferring of the search agents from the global stage to local and propel them toward the best solution as well.

4. Benchmarks on black widow optimization algorithm and experimental results

In this section, the Black Widow Optimization Algorithm (BWO) is tested with 51 benchmark functions, all of which are minimization functions. Since the global optimum of the benchmark functions is known in advance so, reaching to the specified level of accuracy is shown the accurateness level of the proposed algorithm. To evaluate the performance of the proposed algorithm, the maximum number of iteration considered as the stop conditions of the experiments in this section. The first 45 benchmark functions are the classical functions employed by various researchers (Digalakis and Margaritis, 2001; Mirjalili and Lewis, 2013; Mirjalili et al., 2014b; Molga and Smutnicki, 2005; Yang, 2010b; Yao et al., 1999). Rest of them are six composite benchmark functions chosen from a CEC 2005 special session (Liang et al., 2005). These functions are expanded, shifted, rotated, and combined various of the classical benchmark functions that provide the highest complexity among the existing functions (Suganthan et al., 2005). The CEC 2005 test functions are listed in Table 8. The simulations have been implemented using Matlab 2015b on a Core i5, 2.50 GHz Samsung laptop with 6 GB of RAM.

4.1. Classical functions

In spite of the fact that the classical benchmark functions are simple to implement, these test functions have been chosen, aiming to compare the results of BWO to those of the existing meta-heuristics. Table 1 lists these benchmark functions. In order to make a comparison, the standard form of GA with roulette wheel selection and also standard PSO, BBO (Simon, 2008) and ABC algorithms are applied to the benchmark functions, and the results of the BWO are compared with all of them.

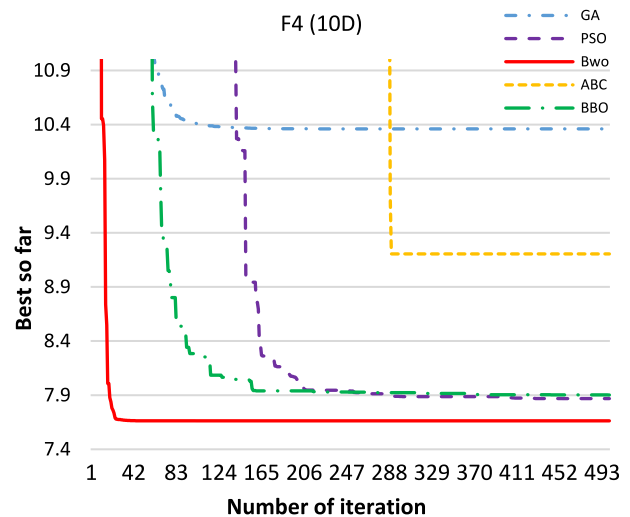

Fig. 7. Convergence of F4 ($n = 10$).

4.1.1. Test functions

The test functions that we have used to validate our experiments are summarized in Table 1, some of which are chosen from Molga and Smutnicki (2005), Jamil and Yang (2013), Qu et al. (2016) and others from benchmark function of CEC2015 (Liang et al., 2014). The global minimum value of the functions are zero, excluding F36, F37, F38, F40 which have global minimum values of “-2.02181”, “1”, “-200”, “-18.5547” respectively. A thorough description of the functions is accessible in the mentioned references.

In Table 1 functions’ names, equations and ranges have been brought and also in the last column, their characteristics are mentioned as M, U, C, S, N which stand for Multi-modal, Uni-modal, Composition, Separable, Non-separable respectively.

4.1.2. Results of the experiments on benchmark functions

The results which are reported in Table 3, have been obtained by over 30 runs for each algorithm with 10, 20, and 50 dimensions and also multiple population sizes and different numbers of iterations. BWO provides better results than the other experimental algorithms for most of the functions, especially in high dimensions. “Best” denotes the best result fitness value in 30 runs. “Mean” and “Median” respectively refer to mean and median of the fitness values in 30 runs. The parameters of the algorithms are set as in Table 2.

In the case of uni-modal functions, the convergence rate of the search algorithm is more significant than the final results, because there are other methods which are specially designed to optimize uni-modal functions. The largest difference in performance between the experimental algorithms occurs with the uni-modal functions, which is due to the significant power of BWO in fast convergence and obtaining desirable results. Moreover, the good convergence rate of BWO could be concluded from Figs. 7, 8, 15, and 16. According to these figures, BWO tends to find the global optimum faster than other algorithms and hence has a higher convergence rate (Rashedi et al., 2009).

Multimodal functions have various local optima and almost are too difficult to optimize. For multimodal functions, the final results are more important since they return the ability of the algorithm in escaping from poor local minima and placed a near-global optimum (Rashedi et al., 2009).

According to the results achieved for functions F2, F19, F21, F25, F28 and F43, and additionally F22, although BBO and PSO have better results in 10-dimensional problems respectively, BWO appears better than the others in 20 and 50 dimensions. About F10 in 10 and 20-dimensional problem, PSO has represented better results, and also in F45 in both 10, and 20-dimensional BBO has reached better results,

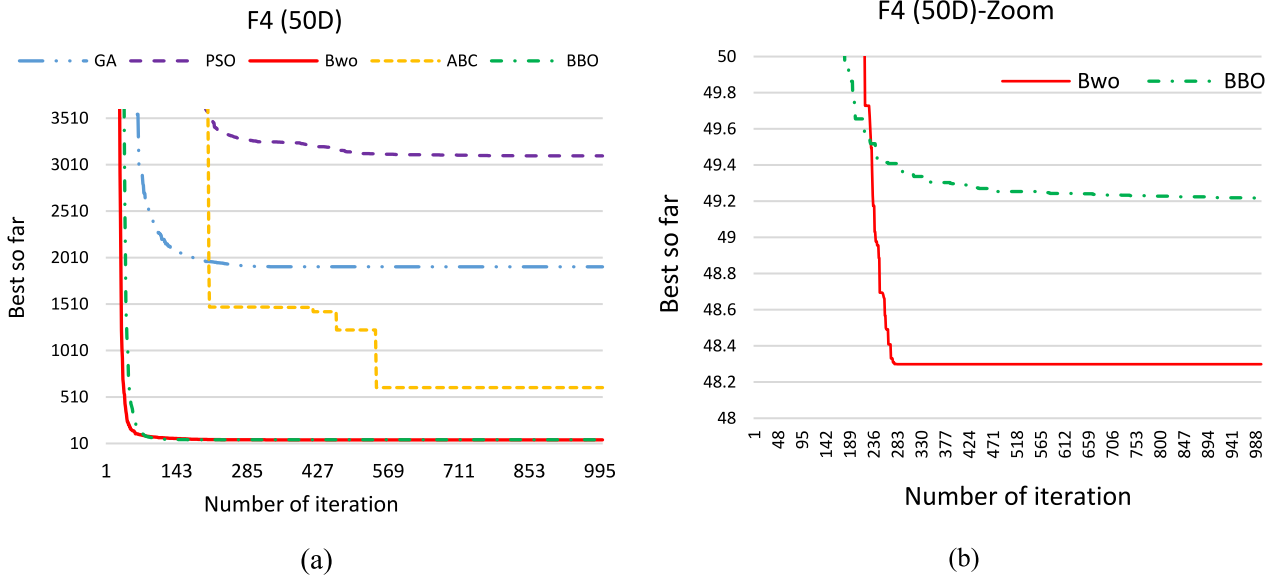

Fig. 8. (a) Convergence of F4 (n = 50) (b) Zoom to Figure (a).

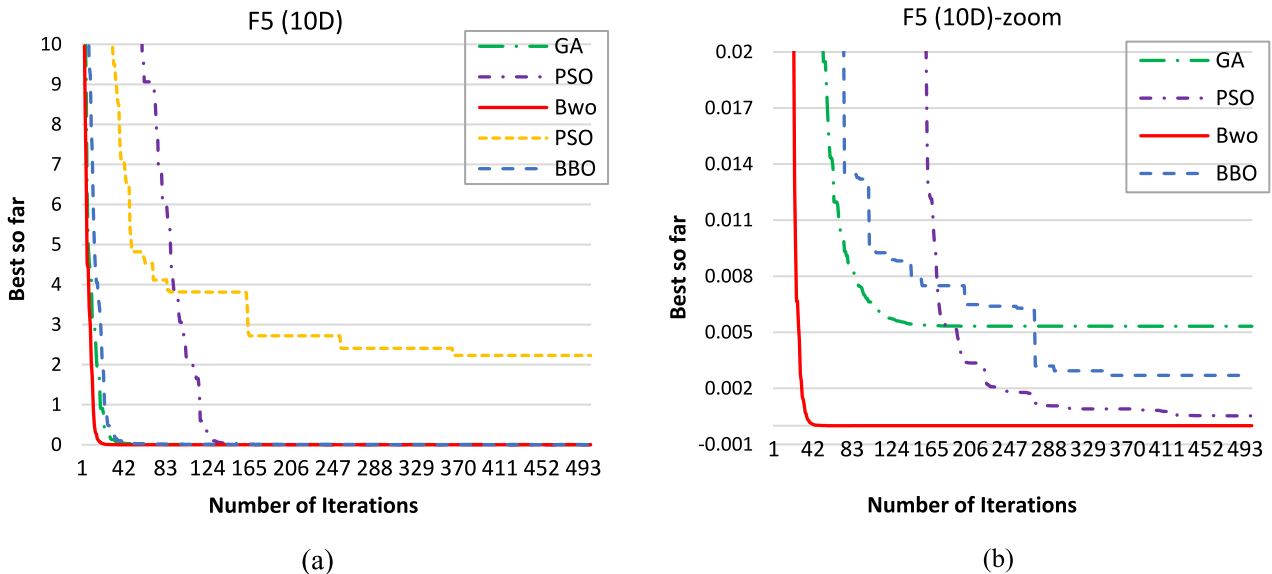

Fig. 9. (a) Convergence of F5 (n = 10), (b) Zoom to figure a.

but in 50 dimensional, BWO has prevailed over them. It seems that by increasing the dimension of the problems, the results' quality of BWO still has stayed in an acceptable state. Furthermore, the results have had better values, compared to the other algorithms. In F31, BWO, PSO, and ABC have provided better results compared to other cases, respectively in dimensions of 10, 20, and 50. It seems that the increase in the problem scale in this function has led to weak resulting of BWO.

Due to the global minima of F36 which has a value of “-2.0218”, ABC has acted better than the others. It has achieved the exact global optima value in all dimension of the problem even for “Best”, “mean”, and “median”. Also, PSO has obtained an appropriate result only in the dimension of 50. Although BWO looks a bit weaker in case of this test function, the difference between its results and the optimal value is negligible, especially in the dimension of 50.

Considering the optimal value of F40, which is “-18.5547”, all of the algorithms excluding PSO have reached to the global optima in all dimensions. To highlight the superiority, the value of “mean”, “Median”, and “std”. also have been compared. Hence it can be found that BWO has resulted better than the other algorithms, and also it

seems that by increasing the number of population, BWO still can obtain relevant results.

Due to the results obtained for the test function F38, it can be seen that all of the experimental algorithms have been able to find the exact value of global minima which has the value of “-200” but “mean”, “median” and also “std”. values have been compared to show the superiority of BWO over the other algorithms. It should be mentioned that this function is not applicable on GA.

About F23, in the dimension of 10, GA, BBO and BWO, all have reached the global optima but in dimension of 20 although BBO achieved the global optima, “mean”, and “median” could not obtain acceptable results. In the dimension of 50, both BWO and GA have reached the global minima.

About F27, in the dimension of 10, BWO outperforms other algorithms. Also, in the dimension of 20, three inclusive algorithms of GA, PSO and BWO have reached the exact global optimal values. In the dimension of 50, PSO cannot obtain acceptable values for “mean” and “median”.

Table 1
Test functions adopted for our experiments.

Function	Equation	Range	Characteristic
F1:Powell Sum (Some of different powers)	$f_1(x) = \sum_{i=1}^n x_i ^{i+1}$	$-5.12 \leq x_i \leq 5.12$	U
F2:Cigar	$f_2(x) = x_1^2 + 10^6 \sum_{i=2}^n x_i^2$	$-5.12 \leq x_i \leq 5.12$	N/A
F3:Discus	$f_3(x) = 10^6 x_1^2 + \sum_{i=2}^n x_i^2$	$-5.12 \leq x_i \leq 5.12$	N/A
F4:Rosenbrock	$f_4(x) = \sum_{i=1}^{n-1} (100(x_i^2 - x_{i+1})^2 + (x_i - 1)^2)$	$-30 \leq x_i \leq 30$	U
F5:Ackley	$f_5(x) = -20 \exp\left(-0.2 \sqrt{\frac{1}{n} \sum_{i=1}^n x_i^2}\right) - \exp\left(\frac{1}{n} \sum_{i=1}^n \cos(2\pi x_i)\right) + 20 + e$	$-35 \leq x_i \leq 35$	MN
F6:Weierstrass	$f_6(x) = \sum_{i=1}^n \left(\sum_{k=0}^{kmax} [a^k \cos(2\pi b^k(x_i + 0.5))] \right) - n \sum_{k=0}^{kmax} [a^k \cos(2\pi b^k \cdot 0.5)]$ a=0.5, b=3, kmax=20	$-10 \leq x_i \leq 10$	M
F7:Griewank	$f_7(x) = \sum_{i=1}^n \frac{x_i^2}{4000} - \prod_{i=1}^n \cos\left(\frac{x_i}{\sqrt{i}}\right) + 1$	$-100 \leq x_i \leq 100$	MN
F8:Rastrigin	$f_8(x) = \sum_{i=1}^n (x_i^2 - 10 \cos(2\pi x_i) + 10)$	$-5.12 \leq x_i \leq 5.12$	MS
F9:Modified Schwefel	$f_9(x) = 418.9829 \times n - \sum_{i=1}^n g(z_i)$, $z_i = x_i + 4.209687462275036e + 002$ $g(z_i) = \begin{cases} z_i \sin(z_i ^{1/2}) & \text{if } z_i \leq 500 \\ (500 - \text{mod}(z_i, 500)) \sin\left(\sqrt{ 500 - \text{mod}(z_i, 500) }\right) - \frac{(z_i - 500)^2}{10000n} & \text{if } z_i > 500 \\ (\text{mod}(z_i , 500) - 500) \sin\left(\sqrt{ \text{mod}(z_i , 500) - 500 }\right) - \frac{(z_i + 500)^2}{10000n} & \text{if } z_i < -500 \end{cases}$	$-100 \leq x_i \leq 100$	C
F10:Katsuura	$f_{10}(x) = \frac{10}{n^2} \prod_{i=1}^n \left(1 + i \sum_{j=1}^{32} \frac{ 2^j x_i - \text{round}(2^j x_i) }{2^j}\right) \frac{10}{n^{1.2}} - \frac{10}{n^2}$	$0 \leq x_i \leq 10$	N/A
F11:HappyCat	$f_{11}(x) = \left \sum_{i=1}^n x_i^2 - n \right ^{\frac{1}{4}} + (0.5 \sum_{i=1}^n x_i^2 + \sum_{i=1}^n x_i) / n + 0.5$	$-5.12 \leq x_i \leq 5.12$	N/A
F12: HGBat	$f_{12}(x) = \left \left(\sum_{i=1}^n x_i^2\right)^2 - \left(\sum_{i=1}^n x_i\right)^2 \right ^{\frac{1}{2}} + (0.5 \sum_{i=1}^n x_i^2 + \sum_{i=1}^n x_i) / n + 0.5$	$-5.12 \leq x_i \leq 5.12$	N/A
F13: Expanded Griwank's plus Rosenbrock	$f_{13}(x) = f_7(f_4(x_1, x_2)) + f_7(f_4(x_2, x_3)) + \dots + f_7(f_4(x_{n-1}, x_n)) + f_7(f_4(x_n, x_1))$	$-5.12 \leq x_i \leq 5.12$	C
f14:Expanded Scaffer's f6	Scaffer's f6 Function : $g(x, y) = 0.5 + \frac{(\sin^2(\sqrt{x^2 + y^2}) - 0.5)}{(1 + 0.001(x^2 + y^2))^2}$ $f_{14}(x) = g(x_1, x_2) + g(x_2, x_3) + \dots + g(x_{n-1}, x_n) + g(x_n, x_1)$	$-5.12 \leq x_i \leq 5.12$	C
f15: Some of different powers	$f_{15} = 1 - \frac{1}{n} \sum_{i=1}^n \cos(kx_i) e^{-\frac{x_i^2}{i}}$	$-\pi \leq x_i \leq \pi$	MS
F16:Sphere	$f_{16} = \sum_{i=1}^n x_i^2$	$-5.12 \leq x_i \leq 5.12$	US
F17: penalized	$f_{17} = \frac{\pi}{n} \left\{ 10 \sin^2(\pi y_1) + \sum_{i=1}^{n-1} (y_i - 1)^2 [1 + 10 \sin^2(\pi y_{i+1})] + (y_n - 1)^2 \right\} + \sum_{i=1}^n u(x_i, 10, 100, 4) y_i$ $u(x_i, a, k, m) = \begin{cases} k(x_i - a)^m & x_i > a \\ 0 & -a < x_i < a \\ k(-x_i - a)^m & x_i < -a \end{cases}$	$-50 \leq x_i \leq 50$	MN
F18: penalized2	$f_{18}(x) = 0.1 \left\{ \sin^2(3\pi x_1) + \sum_{i=1}^{n-1} (x_i - 1)^2 [1 + \sin^2(3\pi x_{i+1})] + (x_n - 1)^2 [1 + \sin^2(2\pi x_n)] \right\} + \sum_{i=1}^n u(x_i, 5, 100, 4)$	$-50 \leq x_i \leq 50$	MN
F19:Quartic	$f_{19}(x) = \sum_{i=1}^n i x_i^4 + \text{random}(0, 1)$	$-1.28 \leq x_i \leq 1.28$	US
F20: Schwefel 1.2	$f_{20}(x) = \sum_{i=1}^n \left(\sum_{j=1}^i x_j \right)^2$	$-100 \leq x_i \leq 100$	UN
F21: Schwefel 2.21	$f_{21}(x) = \max_i \{ x_i , 1 \leq i \leq n \}$	$-100 \leq x_i \leq 100$	UN
F22: Schwefel 2.22	$f_{22}(x) = \sum_{i=1}^n x_i + \prod_{i=1}^n x_i $	$-10 \leq x_i \leq 10$	UN
F23: Step 2	$f_{23}(x) = \sum_{i=1}^n (x_i + 0.5)^2$	$-200 \leq x_i \leq 200$	U
F24: Alpine1	$f_{24}(x) = \sum_{i=1}^n x_i \sin(x_i) + 0.1 x_i $	$-10 \leq x_i \leq 10$	M
F25: Csendes	$f_{25}(x) = \sum_{i=1}^n x_i^6 \left(2 + \sin \frac{1}{x_i} \right)$	$-1 \leq x_i \leq 1$	M

(continued on next page)

Table 1 (continued).

Function	Equation	Range	Characteristic
F26: Rotated Ellipse	$f_{26}(x) = 7x_1^2 - 6\sqrt{3}x_1x_2 + 13x_2^2$	$-500 \leq x_i \leq 500$	U
F27:Rotated Ellipse2	$f_{27}(x) = x_1^2 - x_1x_2 + x_2^2$	$-500 \leq x_i \leq 500$	U
F28: Schwefel 2.4	$f_{28}(x) = \sum_{i=1}^n (x_i - 1)^2 + (x_1 - x_i^2)^2$	$0 \leq x_i \leq 10$	M
F29: Sum Squares	$f_{29}(x) = \sum_{i=1}^n ix_i^2$	$-10 \leq x_i \leq 10$	U
F30: Step	$f_{30}(x) = \sum_{i=1}^n (x_i)$	$-100 \leq x_i \leq 100$	US
F31: Schewefel	$f_{31}(x) = \sum_{i=1}^n 418.9829 - x_i \sin(\sqrt{ x_i })$	$-500 \leq x_i \leq 500$	M
F32: Xin-She Yang1	$f_{45}(x) = \sum_{i=1}^n \epsilon_i x_i ^i$ <i>Where ϵ_i is a random variable uniformly distributed in [0, 1]</i>	$-5 \leq x_i \leq 5$	S
F33: Schaffer	$f_{33}(x) = 0.5 + \frac{\sin^2(x_1^2 - x_2^2) - 0.5}{1 + 0.001(x_1^2 + x_2^2)^2}$	$-100 \leq x_i \leq 100$	UN
F34	$f_{34}(x) = x \cdot \text{sgn}(x)$	$-1.0 \leq x_i \leq 2.0$	
F35	$f_{35}(x) = \sum_{i=1}^n [x_i]$	$-5.12 \leq x_i \leq 5.12$	
F36: Adjiman	$f_{36}(x) = \cos(x_1) \sin(x_2) - \frac{x_1}{(x_2^2 + 1)}$	$-1 \leq x_1 \leq 2$ $-1 \leq x_2 \leq 1$	M
F37: Bartels Conn	$f_{37}(x) = x_1^2 + x_2^2 + x_1x_2 + \sin(x_1) + \cos(x_2) $	$-500 \leq x_i \leq 500$	M
F38: Ackley 2	$f_{38}(x) = -200e^{-0.02\sqrt{x_1^2+x_2^2}}$	$-500 \leq x_i \leq 500$	U
F39: eggcrate	$f_{39}(x, y) = x^2 + y^2 + 25(\sin^2 x + \cos^2 y)$	$(x, y) \in [-2\pi, 2\pi] \times [-2\pi, 2\pi]$	M
F40	$f_{13}(x, y) = x \sin(4x) + 1.1y \sin(2y)$	$0 \leq x, y \leq 10$	
F41:Powell Singular 2	$f_{41}(x) = \sum_{i=1}^{n-2} (x_{i-1} + 10x_i)^2 + 5(x_{i+1} - x_{i+2})^2 + (x_i - 2x_{i+1})^4 + 10(x_{i-1} - x_{i+2})^4$	$-4 \leq x_i \leq 5$	UN
F42: Quintic	$f_{42}(x) = \sum_{i=1}^n x_i^5 - 3x_i^4 + 4x_i^3 + 2x_i^2 - 10x_i - 4 $	$-10 \leq x_i \leq 10$	MS
F43:Qing	$f_{43}(x) = \sum_{i=1}^n (x_i^2 - i)^2$	$-500 \leq x_i \leq 500$	MS
F44: Salomon	$f_{44}(x) = 1 - \cos\left(2\pi\sqrt{\sum_{i=1}^n x_i^2}\right) + 0.1\sqrt{\sum_{i=1}^n x_i^2}$	$-100 \leq x_i \leq 100$	MN
F45: Dixon & Price	$f_{45}(x) = (x_1 - 1)^2 + \sum_{i=1}^n i(2x_i^2 - x_{i-1})^2$	$-10 \leq x_i \leq 10$	UN

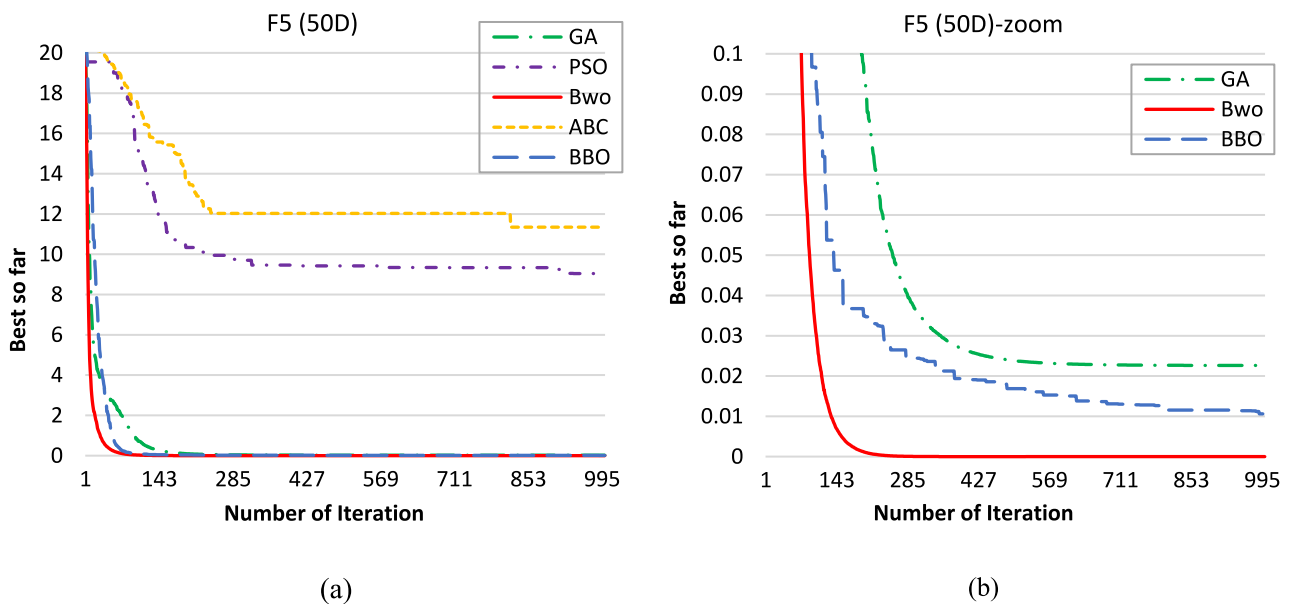

Fig. 10. (a) Convergence of F5 (n = 50), (b) Zoom to figure a.

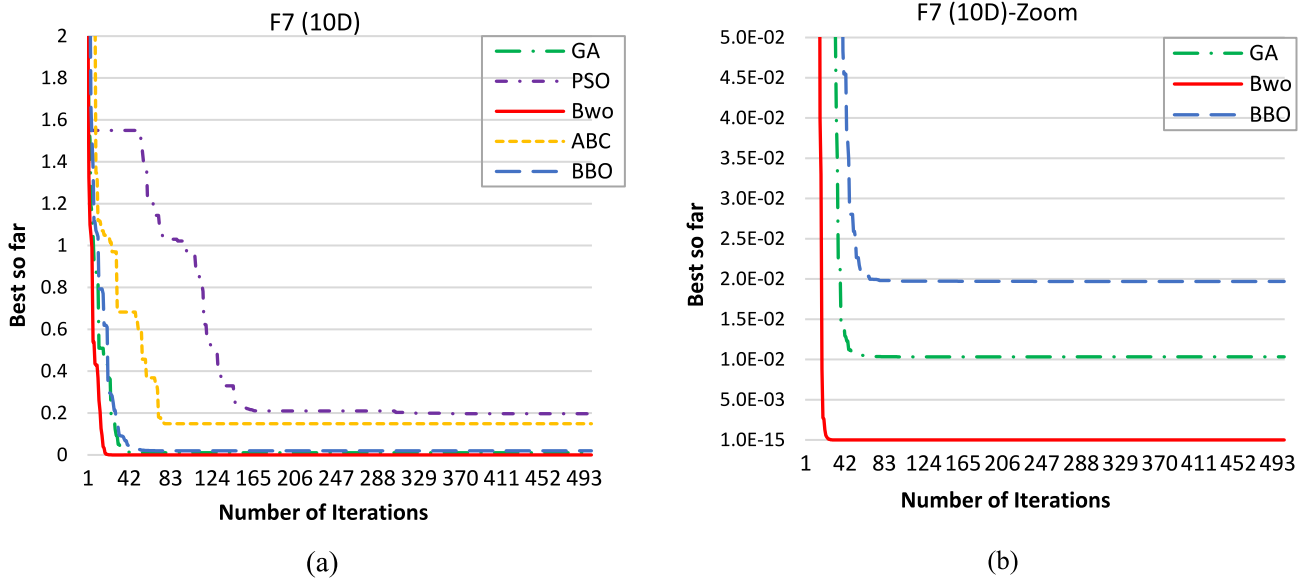

Fig. 11. (a) Convergence of F7 (n = 10), (b) Zoom to figure a.

Table 2
Parameters values.

Algorithm	Parameter	Value	Parameter	Value
GA	pc = crossover rate	0.67	Mutation rate	0.33
PSO	Inertia weight	2	Best global experience	2.2
	Best personal experience	2.4	w-damp	0.98
BWO	pp = procreate rate	0.6	Pm = mutation rate	0.4
	CR = cannibalism rate	0.44		
ABC	The number of food sources	Popsize/2	Limit	15
BBO	Rate of keeping habitat	0.6	Absorption coefficient	0.9
	Mutation rate	0.4		

In functions F30, F33, F34, F37 and F39, BWO and some of the experimental algorithms have obtained the global optima, but in some cases the “Best” values of the algorithms are equal, the values of “mean” and “median” have been compared in order to select the best-operated algorithm.

4.1.3. Statistical experiments

Table 4 demonstrates the statistical comparison of some well-known benchmark functions for dimensional of 10 with the population size of 200 and also in Table 5 the experimental algorithms are investigated for the dimension of 50 with a population size of 300. Both of the experiments have the maximum iteration number of 2000 and the best results of over 30 times running, have been recorded in mentioned tables. “Best”, “mean”, “median”, “worst” and “std”. respectively denote the best, mean, median, the worst and standard deviation values in over 30 runs. The mean and standard deviation metrics demonstrate the stability of the algorithm. Considering the stochastic feature of algorithms, it is still needed for conducting more statistical tests (Derrac et al., 2011). Only the overall performance of algorithms can be compared by the mean and standard deviation metrics. But, a statistical test by considering the outcomes of each run verifies that the outcomes are statistically remarkable. In this regard, this research conducted the Wilcoxon rank-sum test (Derrac et al., 2011; Mirjalili and Lewis, 2013), which is a non-parametric test in statics. Technically speaking, this test returns p-values parameters. Any p-value less than 0.05 indicates the remarkable statistical superiority of outcomes. The p-values in Table 6 proves the statistically impressive superiority of the BWO algorithm.

As it is obvious from the comparison of mentioned tables, by increasing the dimension of the problems, and the population size, the performance of BWO algorithm is much considerable in comparison

to the other experimental algorithms. In the dimension of 10 (see Table 4) the performance of BWO is a little bit weaker in F1 and F31 in the case of “Best” value, but in F7 and F8 it has reached to the exact global optimum value. In the case of “mean”, “worst”, and “std”. values, the proposed algorithm has appeared poor except for F7 and F8. About “Median” values, it can be said that the performance of BWO is acceptable in all cases except for F31. In the dimension of 50 (see Table 5) the performance of BWO in the case of “Best” value is outstanding in all of the test functions. Due to the increasing dimension and population size in Table 5, F7 and F8 still have achieved the exact global optima, especially in F8 with the “std”. value of zero which is so phenomenal.

4.1.4. High dimensional experiments

In Table 7, the performance of BWO is compared with other experimental algorithms for high dimensional problems with some famous benchmark functions. The algorithms are conducted over 30 runs for each test function, and the simulation results indicate that BWO has obtained remarkable performance in the accuracy of the solution for global optimization.

4.1.5. Convergence experiments

Figs. 7–16 depict the fitness minimization plot of all experimental algorithms for test functions F4, F5, F7, F8, and F16. To make the results obvious, the exact numbers, which have been obtained from the simulations, are shown in Table 8. The most interesting point seen in these figures is the fast convergence of Black widow optimization.

To perform the convergence tests, each of the algorithms has been executed once for each dimension. In dimension 10 tests, the number of maximum iteration and the population size are set to 500 and 200 and also in 50-dimensional tests maximum iteration number, and the population size is considered 1000 and 500 respectively. As can be seen from Table 8, in most of the cases, BWO results are significantly better than other algorithms, especially in the case of F7 and F8 (50-dimensional tests) which have obtained the exact optimal solution. Moreover, the figures clearly show the fast convergence feature of black widow optimization algorithm in comparison to the others.

Furthermore, in order to more illustration of the convergence speed of the proposed method, the convergence point of the experiments as mentioned earlier have been depicted in Figs. 17 and 18 for 10D and 50D experiments respectively; also, the maximum iteration of the experiments was considered 500 and 1000 correspondingly. With regards to these figures, it can be concluded that the proposed method

Table 3
Comparing the results in different dimensions with some well-known optimization algorithms.

f		F1			F2			F3		
nvar		10	20	50	10	20	50	10	20	50
npop		100	150	200	100	150	200	100	150	200
Maxiter		500	1000	1500	500	1000	1500	500	1000	1500
GA	Best	4.09E-24	3.32E-33	6.82E-17	1.11E-01	3.81E-01	1.87E+01	1.50E-08	1.02E-06	2.85E-05
	Mean	1.68E-09	3.05E-13	3.73E-11	8.24E-01	1.39E+00	2.66E+01	4.36E-03	4.42E-03	1.10E-02
	Median	2.60E-11	1.39E-18	3.17E-13	6.17E-01	1.34E+00	2.63E+01	1.19E-03	6.50E-04	3.18E-03
PSO	Best	1.12E-18	7.47E-15	3.79E-09	9.07E-04	5.88E+00	3.76E+05	1.10E-04	1.40E-06	9.04E+00
	Mean	1.21E-12	1.78E-09	1.66E-04	16.6E+00	2.12E+02	1.65E+06	1.79E-02	2.18E+01	9.15E+01
	Median	4.13E-14	3.83E-11	2.67E-05	26.2E+00	1.01E+02	1.54E+06	6.18E-03	2.62E+01	8.53E+01
BWO	Best	1.58E-28	2.00E-36	1.13E-32	7.60E-03	3.44E-02	4.22E-01	1.13E-08	3.12E-07	2.98E-07
	Mean	1.03E-12	5.93E-17	3.09E-17	1.81E-01	2.60E-01	1.78E+00	6.90E-04	6.77E-04	3.43E-03
	Median	2.28E-15	1.43E-18	8.87E-21	9.85E-02	2.50E-01	1.61E+00	9.16E-05	2.44E-04	3.45E-04
ABC	Best	3.35E-12	9.34E-10	3.63E-06	2.29E-02	4.26E+00	7.78E+01	3.63E-06	7.58E-05	2.31E-03
	Mean	4.55E-09	2.14E-07	2.40E-04	6.67E-01	1.44E+01	1.17E+03	1.08E-03	3.09E-03	7.42E-02
	Median	9.34E-10	9.09E-08	1.74E-04	5.97E-01	1.14E+01	8.62E+02	3.97E-04	2.44E-03	3.83E-02
BBO	Best	3.12E-22	5.70E-21	1.64E-18	1.84E-04	4.24E+02	1.12E+05	1.26E-07	5.57E-02	1.19E+00
	Mean	1.81E-16	5.98E-18	1.86E-13	2.98E-01	2.71E+03	2.11E+05	1.31E-06	2.62E-01	2.31E+00
	Median	2.44E-17	7.98E-19	1.02E-14	4.79E-02	2.01E+03	1.93E+05	6.69E-07	1.88E-01	2.22E+00
The best result		BWO	BWO	BWO	BBO	BWO	BWO	BWO	BWO	BWO
F		F4			F5			F6		
nvar		10	20	50	10	20	50	10	20	50
Npop		100	150	200	100	150	200	100	150	200
Maxiter		500	1000	1500	500	1000	1500	500	1000	1500
GA	Best	4.45E-01	4.07E+00	3.89E+01	4.82E-05	3.40E-07	2.92E-12	1.20E-05	6.87E-03	7.57E-04
	Mean	1.02E+01	3.87E+01	1.38E+02	4.97E-02	1.05E-01	4.62E-02	7.62E-02	2.37E-01	5.82E-01
	Median	7.40E+00	1.82E+01	1.51E+02	1.22E-02	2.05E-02	1.76E-02	4.15E-02	1.70E-01	3.91E-01
PSO	Best	9.12E-01	2.18E+01	5.90E+04	8.44E-05	9.86E-01	7.10E+00	5.72E-02	8.17E-01	2.06E+01
	Mean	2.38E+02	9.70E+03	2.08E+05	4.43E-03	2.50E+00	1.01E+01	1.98E-01	2.55E+00	2.79E+01
	Median	1.61E+01	2.49E+02	1.95E+05	2.68E-03	2.52E+00	1.02E+02	1.89E-01	2.18E+00	2.64E+01
BWO	Best	3.54E-01	2.64E+00	2.21E+01	2.78E-13	7.99E-15	2.93E-14	1.17E-11	0	0
	Mean	7.90E+00	2.47E+01	1.13E+02	3065E-03	8.84E-05	3.70E-14	5.01E-03	4.10E-03	7.57E-03
	Median	7.22E+00	1.71E+01	1.01E+02	4.53E-05	6.33E-11	3.29E-14	8.42E-04	7.81E-04	1.07E-03
ABC	Best	4.52E+00	2.68E+01	1.00E+02	1.17E-01	1.41E+00	9.19E+00	3.01E-01	1.88E+00	6.55E+00
	Mean	1.38E+01	5.10E+01	3.18E+02	3.23E-01	2.27E+00	1.15E+01	5.86E-01	2.73E+00	9.07E+00
	Median	1.14E+01	5.09E+01	3.09E+02	2.72E-01	2.31E+00	1.16E+01	5.63E-01	2.72E+00	9.30E+00
BBO	Best	6.52E-01	1.42E+01	5.32E+02	1.45E-03	3.05E-03	8.20E-03	2.46E-02	6.67E-02	2.81E-01
	Mean	5.39E+00	8.03E+01	2.19E+03	1.89E-01	2.89E-01	2.48E-01	3.37E-02	9.70E-02	4.90E-01
	Median	4.68E+00	5.68E+01	2.11E+03	1.95E-03	4.55E-03	9.75E-03	3.39E-02	7.55E-02	4.30E-01
The best result by		BWO	BWO	BWO	BWO	BWO	BWO	BWO	BWO	BWO
F		F7			F8			F9		
nvar		10	20	50	10	20	50	10	20	50
Npop		100	150	200	100	150	200	100	150	200
Maxiter		500	1000	1500	500	1000	1500	500	1000	1500
GA	Best	7.33E-08	2.44E-10	2.59E-12	4.81E-10	3.29E-08	4.01E-06	1.30E-04	2.65E-04	1.49E-03
	Mean	4.29E-02	4.96E-02	5.68E-02	5.73E-01	4.94E-02	1.12E-01	1.78E-04	3.16E-04	1.97E-03
	Median	3.43E-02	1.41E-02	2.05E-04	7.90E-03	1.75E-03	5.97E-02	1.75E-04	3.13E-04	2.03E-03
PSO	Best	1.22E-01	3.68E-01	1.17E+00	2.03E-01	1.75E+01	1.56E+02	1.27E-04	9.80E-02	1.11E+02
	Mean	5.48E-01	8.43E-01	1.67E+00	7.90E+00	5.11E+01	3.28E+02	1.40E-04	7.45E-01	4.29E+02
	Median	5.61E-01	8.83E-01	1.55E+00	6.09E+00	5.80E+01	3.43E+02	1.30E-04	4.49E-01	4.52E+02
BWO	Best	0	0	0	0	0	0	1.27E-04	2.58E-04	6.59E-04
	Mean	6.99E-03	1.33E-03	2.48E-02	2.27E-02	2.89E-03	0	1.38E-04	2.69E-04	6.96E-04
	Median	1.95E-05	3.85E-16	2.78E-16	1.93E-04	3.13E-06	0	1.34E-04	2.68E-04	6.90E-04
ABC	Best	5.19E-02	2.31E-01	8.98E-01	1.30E+01	8.68E+01	1.19E+02	1.22E+00	1.80E+02	3.62E+03
	Mean	1.51E-01	4.15E-01	1.10E+00	2.90E+01	1.14E+02	1.51E+02	2.92E+01	6.35E+02	5.59E+03
	Median	1.61E-01	4.31E-01	1.09E+00	2.92E+01	1.17E+02	1.53E+02	2.79E+01	6.35E+02	5.57E+03
BBO	Best	7.40E-03	1.02E-05	6.30E-05	1.99E+00	9.85E+00	6.70E+01	1.29E-04	2.07E-02	3.35E+00
	Mean	7.12E-02	2.56E-03	1.32E-03	5.87E+00	2.26E+01	1.02E+02	1.30E-04	2.89E-01	9.42E+00
	Median	6.02E-02	1.60E-05	9.31E-05	5.47E+00	2.20E+01	1.03E+02	1.29E-04	1.80E-01	9.12E+00

(continued on next page)

achieves the minimum convergence point in the majority of the experiments and only in 2 of them the proposed method cannot overcome other algorithms. As a result, it can be claimed that the proposed method in 80% of experiments can converge with high speed in comparison with other algorithms.

4.2. Evaluation of composite functions

Shifted, rotated, combined, and biased form of other uni-modal and multi-modal benchmark functions are known as composite functions (Digalakis and Margaritis, 2001; Yang, 2010b; Yao et al., 1999)s which

Table 3 (continued).

f		F1			F2			F3		
The best result		BWO	BWO	BWO	BWO	BWO	BWO	BWO	BWO	BWO
F		F10			F11			F12		
Nvar		10	20	50	10	20	50	10	20	50
Npop		100	150	200	100	150	200	100	150	200
Maxiter		500	1000	1500	500	1000	1500	500	1000	1500
GA	Best	3.90E-04	3.15E-04	3.86E-04	3.85E-02	1.28E-01	3.34E-01	1.51E-01	3.41E-01	4.03E-01
	Mean	2.97E-03	1.11E-03	6.36E-04	1.18E-01	2.17E-01	5.17E-01	3.74E-01	4.39E-01	5.30E-01
	Median	2.77E-03	1.02E-03	6.08E-04	9.99E-02	2.16E-01	5.07E-01	4.07E-01	4.39E-01	4.61E-01
PSO	Best	1.67E-08	1.59E-05	3.86E-04	1.39E-01	3.65E-01	4.96E-01	1.64E-01	2.30E-01	3.15E-01
	Mean	2.89E-01	3.57E-02	3.30E-03	2.61E-01	5.90E-01	8.02E-01	3.00E-01	6.04E-01	7.39E-01
	Median	9.07E-02	2.38E-02	2.50E-03	2.55E-01	5.94E-01	7.99E-01	2.78E-01	4.25E-01	6.72E-01
BWO	Best	2.63E-04	2.62E-04	1.73E-04	1.21E-02	4.18E-02	1.71E-01	1.47E-01	2.10E-01	3.33E-01
	Mean	2.45E-03	6.60E-04	1.44E-03	3.25E-02	7.37E-02	2.60E-01	3.72E-01	4.31E-01	4.80E-01
	Median	2.08E-03	5.68E-04	1.10E-03	3.36E-02	7.07E-02	2.60E-01	4.09E-01	4.21E-01	4.56E-01
ABC	Best	1.07E-02	2.97E-02	8.29E-02	3.35E-01	9.84E-01	4.31E+00	2.34E-01	2.08E+00	1.09E+02
	Mean	4.37E-02	7.05E-02	1.54E-01	6.78E-01	1.79E+00	5.09E+00	6.53E-01	1.28E+01	1.54E+02
	Median	4.08E-02	6.66E-02	1.40E-01	7.18E-01	1.74E+00	5.08E+00	5.74E-01	1.35E+01	1.56E+02
BBO	Best	1.49E-03	2.26E-02	6.17E-02	4.16E-02	1.10E-01	2.82E-01	1.70E-01	3.18E-01	3.75E-01
	Mean	7.82E-03	9.79E-02	1.77E-01	1.06E-01	1.90E-01	5.47E-01	4.41E-01	4.32E-01	4.83E-01
	Median	2.80E-03	8.38E-02	1.56E-01	9.85E-02	1.87E-01	5.48E-01	4.59E-01	4.22E-01	4.72E-01
The best result		PSO	PSO	BWO	BWO	BWO	BWO	BWO	BWO	BWO
F		F13			F14			F15		
Nvar		10	20	50	10	20	50	10	20	50
Npop		100	150	200	100	150	200	100	150	200
Maxiter		500	1000	1500	500	1000	1500	500	1000	1500
GA	Best	1.16E-01	4.19E-01	6.91E-01	7.79E-02	1.58E-01	6.53E-01	5.62E-13	3.98E-10	5.87E-10
	Mean	2.48E-01	5.63E-01	7.59E-01	1.93E-01	4.11E-01	1.10E+00	6.45E-03	1.89E-03	1.20E-03
	Median	2.41E-01	5.67E-01	7.70E-01	9.76E-02	3.25E-01	1.01E+00	4.18E-04	3.49E-04	2.56E-04
PSO	Best	9.10E-02	7.06E-01	2.24E+01	9.65E-02	5.78E-01	3.23E+00	1.19E-01	3.66E-01	5.56E-01
	Mean	4.16E-01	1.59E+00	3.76E+02	3.71E-01	1.33E+00	6.38E+00	2.32E-01	4.50E-01	6.79E-01
	Median	3.72E-01	1.20E+00	1.47E+02	3.72E-01	1.37E+00	6.45E+00	2.32E-01	4.53E-01	6.88E-01
BWO	Best	5.93E-02	3.37E-01	6.60E-01	5.83E-02	1.57E-01	4.18E-01	2.66E-15	0	0
	Mean	2.35E-01	5.45E-01	7.46E-01	1.03E-01	3.04E-01	9.31E-01	1.79E-04	1.89E-04	2.30E-06
	Median	2.07E-01	5.62E-01	7.56E-01	4.72E-02	3.16E-01	8.48E-01	4.99E-06	4.76E-08	2.22E-16
ABC	Best	7.33E-01	1.27E+00	7.05E+02	2.40E-01	1.30E+00	3.03E+00	5.94E-02	1.79E-01	3.45E-01
	Mean	1.05E+00	3.91E+00	1.27E+05	5.06E-01	2.38E+00	4.77E+00	1.04E-01	2.14E-01	3.87E-01
	Median	1.07E+00	2.82E+00	1.19E+05	4.91E-01	2.48E+00	4.86E+00	1.06E-01	2.14E-01	3.86E-01
BBO	Best	1.60E-01	3.72E-01	1.00E+00	7.78E-02	2.66E-01	3.67E+00	5.33E-02	6.21E-02	1.77E-01
	Mean	2.87E-01	7.40E-01	1.09E+00	1.31E-01	8.41E-01	5.50E+00	1.22E-01	1.69E-01	2.90E-01
	Median	2.75E-01	7.29E-01	1.08E+00	9.72E-02	7.48E-01	5.21E+00	1.08E-01	1.57E-01	2.90E-01
The best result		BWO	BWO	BWO	BWO	BWO	BWO	BWO	BWO	BWO
F		F16			F17			F18		
Nvar		10	20	50	10	20	50	10	20	50
Npop		100	150	200	100	150	200	100	150	200
Maxiter		500	1000	1500	500	1000	1500	500	1000	1500
GA	Best	1.30E-11	5.86E-15	1.39E-15	1.14E-14	1.22E-11	1.02E-05	6.38E-07	4.48E-05	5.45E-10
	Mean	6.15E-04	6.82E-04	6.46E-04	3.02E-03	1.32E-03	1.53E-05	1.72E-05	5.43E-02	2.21E-01
	Median	7.90E-06	1.77E-05	2.23E-05	1.41E-04	9.58E-05	1.36E-05	1.48E-05	2.91E-02	3.28E-02
PSO	Best	8.33E-05	2.75E-03	9.66E-01	1.06E-07	9.25E-01	1.50E+01	2.00E-06	4.07E-01	8.23E+02
	Mean	8.60E-03	1.33E-02	3.52E+00	1.33E-02	6.72E+00	1.94E+04	3.29E-03	6.56E+00	1.36E+05
	Median	3.72E-03	7.55E-03	3.39E+00	8.27E-06	6.02E+00	4.58E+03	1.26E-03	2.47E+00	4.98E+04
BWO	Best	2.35E-30	3.41E-75	2.57E-44	5.28E-17	2.36E-32	1.64E-07	1.81E-07	1.35E-32	1.35E-32
	Mean	2.45E-07	8.90E-08	4.25E-39	3.13E-06	1.96E-06	1.86E-06	1.70E-05	1.45E-03	1.98E-07
	Median	6.10E-12	1.36E-46	2.03E-43	2.20E-09	1.35E-09	7.03E-07	6.71E-06	2.80E-05	6.02E-28
ABC	Best	4.82E-05	2.85E-03	4.76E-02	1.96E-04	1.06E-03	3.67E-02	3.83E-04	7.97E-04	1.32E-01
	Mean	6.54E-04	8.89E-03	2.17E-01	2.14E-03	7.05E-03	1.63E-01	1.91E-03	1.70E-02	4.78E-01
	Median	4.38E-04	8.18E-03	1.89E-01	1.89E-03	6.43E-03	1.51E-01	1.62E-03	1.49E-02	4.23E-01
BBO	Best	5.70E-08	2.63E-07	3.57E-06	1.13E-07	3.56E-07	1.86E-06	2.25E-07	3.79E-06	4.48E-05
	Mean	1.69E-07	4.67E-07	4.94E-06	2.12E-07	5.18E-03	2.00E-02	7.34E-04	8.80E-03	2.57E-02
	Median	1.71E-07	4.86E-07	4.99E-06	2.17E-07	5.33E-07	2.93E-06	9.14E-07	1.10E-02	1.10E-02

(continued on next page)

are listed in Table 9. In this table, Dim states dimension of the function, f_{min} indicates the optimum value of the function, and Range shows the

function's search space boundary. As shown in Fig. 19 (Dhiman and Kumar, 2017; Mirjalili and Lewis, 2016; Mirjalili et al., 2016; Mirjalili,

Table 3 (continued).

f		F1			F2			F3		
The best result		BWO	BWO	BWO	BWO	BWO	BWO	BWO	BWO	BWO
F		F19			F20			F21		
Nvar		10	20	50	10	20	50	10	20	50
Npop		100	150	200	100	150	200	100	150	200
Maxiter		500	1000	1500	500	1000	1500	500	1000	1500
GA	Best	1.24E+00	4.20E+00	1.37E+01	3.04E-09	2.91E-03	1.14E-04	5.65E-02	1.84E-01	6.81E-01
	Mean	1.54E+00	4.59E+00	1.59E+01	6.43E+00	5.05E-03	2.62E+02	1.38E-01	2.66E-01	9.25E-01
	Median	1.52E+00	4.55E+00	1.61E+01	1.07E-01	4.00E-03	1.42E+02	1.35E-01	2.64E-01	9.17E-01
PSO	Best	1.38E+00	5.99E+00	2.50E+01	3.10E-05	1.44E+00	1.46E+04	7.04E-02	7.83E+00	4.45E+01
	Mean	2.28E+00	6.99E+00	3.01E+01	7.61E-03	7.25E+02	8.87E+04	6.39E-01	1.51E+01	5.31E+01
	Median	2.30E+00	6.94E+00	3.05E+01	3.23E-03	4.17E+01	7.88E+04	4.97E-01	1.55E+01	5.37E+01
BWO	Best	2.30E+00	3.63E+00	1.22E+01	8.34E-11	4.38E-23	3.55E-10	2.75E-02	1.05E-01	3.88E-01
	Mean	1.33E+00	4.17E+00	1.38E+01	1.34E-02	2.10E-10	3.28E-08	7.74E-02	1.58E-01	4.74E-01
	Median	1.34E+00	4.18E+00	1.39E+01	2.91E-04	1.15E-10	5.16E-08	8.63E-02	1.53E-01	4.77E-01
ABC	Best	2.02E+00	7.48E+00	3.74E+01	5.34E-03	1.89E+00	6.73E+01	1.41E+01	3.38E+01	7.16E+01
	Mean	2.77E+00	9.02E+00	5.29E+01	2.23E-01	5.11E+00	1.14E+03	2.44E+01	5.05E+01	7.72E+01
	Median	2.80E+00	8.95E+00	5.29E+01	1.95E-01	4.30E+00	9.07E+02	2.48E+01	5.14E+01	7.73E+01
BBO	Best	1.11E+00	3.68E+00	1.38E+01	3.50E-05	4.19E-04	1.88E-02	1.69E-03	8.03E-01	4.48E+00
	Mean	1.47E+00	4.49E+00	1.58E+01	1.04E-04	7.56E-04	9.67E-02	2.91E-03	2.97E+00	7.42E+00
	Median	1.50E+00	4.53E+00	1.60E+01	1.00E-04	7.20E-04	3.44E-02	3.02E-03	2.95E+00	6.69E+00
The best result		BBO	BWO	BWO	BWO	BWO	BWO	BBO	BWO	BWO
F		F22			F23			F24		
Nvar		10	20	50	10	20	50	10	20	50
Npop		100	150	200	100	150	200	100	150	200
Maxiter		500	1000	1500	500	1000	1500	500	1000	1500
GA	Best	7.11E-04	1.34E-03	1.90E-02	0	0	0	4.68E-05	1.19E-04	1.26E-03
	Mean	2.22E-03	3.78E-03	2.89E-02	0	0	0	3.91E-04	4.27E-04	1.95E-03
	Median	2.22E-03	3.60E-03	3.04E-02	0	0	0	1.30E-04	2.49E-04	1.72E-03
PSO	Best	4.72E-05	5.73E-02	4.50E+00	0.00E+00	6.00E+00	2.89E+03	1.00E-04	2.31E-02	2.27E+00
	Mean	2.18E-03	4.01E-01	1.65E+01	2.33E-01	4.39E+01	6.49E+03	4.77E-02	8.31E-01	2.09E+01
	Median	9.24E-03	3.67E-01	1.60E+01	0.00E+00	2.85E+01	5.48E+03	3.40E-03	4.19E-01	1.71E+01
BWO	Best	3.22E-04	8.25E-04	3.41E-03	0	0	0	1.62E-05	4.72E-05	1.69E-04
	Mean	1.54E-04	1.92E-03	6.05E-03	0	0	0	5.85E-05	1.10E-04	3.29E-04
	Median	1.37E-04	1.79E-03	5.74E-03	0	0	0	5.69E-05	1.04E-04	3.41E-04
ABC	Best	2.31E-02	2.78E-01	4.45E+00	0.00E+00	2.00E+00	1.63E+02	9.88E-03	3.66E-01	6.00E+00
	Mean	8.13E-02	5.75E-01	7.20E+00	1.93E+00	1.47E+01	1.05E+03	7.99E-02	8.28E-01	9.82E+00
	Median	7.49E-02	5.79E-01	7.16E+00	2.00E+00	1.45E+01	8.33E+02	6.34E-02	8.32E-01	9.92E+00
BBO	Best	7.34E-04	4.63E-02	2.40E+00	0	0	1.72E+02	6.76E-05	2.42E-03	1.71E+00
	Mean	9.50E-04	2.08E-01	3.47E+00	0	8.23E+00	3.29E+02	1.17E-04	2.06E-02	3.46E+00
	Median	9.46E-04	2.00E-01	3.43E+00	0	5.00E+00	3.20E+02	1.08E-04	1.29E-02	3.46E+00
The best result		PSO	BWO	BWO	GA-BWO-BBO	GA-BWO	GA-BWO	BWO	BWO	BWO
F		F25			F26			F27		
Nvar		10	20	50	2	2	2	2	2	2
Npop		100	150	200	100	150	500	100	200	500
Maxiter		500	1000	1500	500	1000	2000	500	1500	1500
GA	Best	8.93E-23	2.19E-21	2.85E-17	7.26E-196	6.29E-312	4.96E-312	4.38E-201	0	0
	Mean	1.03E-20	1.73E-20	7.01E-17	1.14E-23	4.29E-143	2.47E-96	5.55E-25	0	0
	Median	2.79E-21	1.62E-20	6.52E-17	1.33E-188	5.36E-308	2.47E-126	4.35E-194	0	0
PSO	Best	2.13E-20	3.04E-10	2.73E-04	6.36E-05	5.23E-05	3.26E-08	4.99E-45	0	0
	Mean	3.23E-14	2.05E-07	1.07E-03	4.58E-04	2.83E-03	4.08E-06	1.49E-43	0	4.31E-04
	Median	9.45E-15	4.72E-08	8.00E-04	2.74E-05	3.42E-05	2.76E-06	2.73E-44	0	4.78E-05
BWO	Best	1.03E-24	4.37E-24	7.56E-21	1.56E-246	2.47E-325	2.47E-323	7.78E-250	0	0
	Mean	2.02E-22	6.02E-23	2.06E-20	9.38E-24	1.36E-155	2.47E-123	5.33E-28	0	0
	Median	2.88E-23	2.83E-23	2.06E-20	2.53E-224	2.47E-323	2.47E-172	8.27E-238	0	0
ABC	Best	1.77E-19	1.14E-12	3.12E-07	8.64E-04	9.25E-09	1.27E-05	7.18E-06	1.47E-10	7.88E-07
	Mean	8.66E-17	7.64E-11	1.14E-05	2.19E-02	4.36E-03	3.27E-04	1.42E-03	4.13E-09	3.71E-05
	Median	3.37E-17	4.15E-11	5.43E-06	1.29E-02	3.35E-03	1.77E-04	5.78E-04	2.59E-09	2.72E-05
BBO	Best	1.11E-27	1.28E-12	3.44E-08	1.06E-22	1.20E-36	3.25E-316	3.29E-84	3.00E-303	0
	Mean	7.32E-27	1.01E-09	2.01E-07	2.13E-11	2.59E-13	1.97E-20	1.49E-10	7.39E-17	1.51E-108
	Median	4.07E-27	2.39E-10	1.25E-07	1.23E-12	3.22E-15	8.92E-167	2.13E-26	1.30E-109	0

(continued on next page)

2015a,b), these functions provide a huge number of local optima and different forms for various areas of the search domain; thus, they are

able to mimic difficulties of real search spaces. Keeping the balance between exploitation and exploration to estimate the global optima of

Table 3 (continued).

f		F1			F2			F3		
The best result		BBO	BWO	BWO	PSO	PSO	PSO	BWO	GA-BWO-PSO	GA-BWO
F		F28			F29			F30		
Nvar		10	20	50	10	20	50	10	20	50
Npop		100	150	200	100	150	200	100	150	200
Maxiter		500	1000	1500	500	1000	1500	500	1000	1500
GA	Best	5.17E-03	9.34E-02	3.13E+01	9.05E-10	3.84E-06	7.04E-06	0	0	0
	Mean	2.42E-02	2.05E-01	4.06E+01	1.10E-01	5.45E-05	1.47E+00	0	0	3.363E-02
	Median	2.33E-02	2.18E-01	4.10E+01	5.20E-03	5.17E-05	8.70E-01	0	0	0.01E+00
PSO	Best	7.45E+01	4.03E+03	3.19E+04	1.51E-07	2.64E-02	9.22E+01	0	0.00E+00	6.40E+01
	Mean	2.43E+03	1.03E+04	4.29E+04	1.76E-04	1.18E+01	7.76E+02	0	2.23E+00	1.62E+02
	Median	2.17E+03	1.10E+04	4.26E+04	2.20E-05	5.20E-01	5.88E+02	0	1.00E+00	1.62E+02
BWO	Best	2.65E-04	7.04E-04	8.92E-02	1.18E-18	4.69E-17	1.71E-10	0	0	0
	Mean	4.09E-04	1.05E-03	9.88E-02	9.21E-04	5.74E-13	2.73E-01	0	0	3.33E-02
	Median	4.10E-04	1.05E-03	9.92E-02	4.65E-07	1.18E-13	1.53E-01	0	0	0.00E+00
ABC	Best	5.58E-02	4.24E-01	8.61E+00	1.03E-03	1.19E-02	1.18E+00	0.00E+00	5.00E+00	7.70E+01
	Mean	2.34E-01	1.52E+00	2.23E+01	3.33E-03	5.87E-02	1.60E+01	6.67E-01	1.05E+01	1.31E+02
	Median	2.13E-01	1.53E+00	2.22E+01	3.01E-03	4.94E-02	1.02E+01	1.00E+00	1.10E+01	1.36E+02
BBO	Best	1.12E-06	2.20E+02	3.13E+03	3.50E-07	1.20E-02	1.46E+01	0	0.00E+00	2.00E+00
	Mean	6.70E-03	3.83E+02	3.83E+03	1.04E-06	2.01E-01	1.04E-03	0	6.67E-02	9.77E+00
	Median	1.20E-03	3.70E+02	3.78E+03	9.67E-07	1.60E-01	4.20E-04	0	0.00E+00	9.00E+00
The best result		BBO	BWO	BWO	BWO	BWO	BWO	Except ABC	GA-BWO	GA-BWO
F		F31			F32			F33		
Nvar		10	20	50	10	20	50	2	2	2
Npop		100	150	200	100	150	200	100	200	500
Maxiter		500	1000	1500	500	1000	1500	500	1500	2000
GA	Best	6.64E+00	2.68E+03	7.88E+03	1.09E-14	1.13E-14	9.33E-11	0	0	0
	Mean	4.01E+02	3.40E+03	9.45E+03	2.99E-08	1.58E-08	2.77E-05	5.91E-03	9.59E-04	2.90E-04
	Median	3.61E+02	3.31E+03	9.29E+03	9.76E-11	4.65E-11	3.03E-08	0	0	0
PSO	Best	1.18E+02	9.92E+02	6.55E+03	2.41E-04	1.90E-02	1.30E+07	0	0	0
	Mean	9.92E+02	2.33E+03	8.23E+03	2.48E-02	6.91E+00	3.27E+11	8.47E-07	2.52E-12	0
	Median	9.54E+02	2.15E+03	7.98E+03	4.74E-03	1.60E+00	4.87E+09	0	0	0
BWO	Best	1.06E+00	2.35E+03	8.57E+03	2.59E-15	3.62E-15	1.17E-12	0	0	0
	Mean	1.81E+02	2.30E+03	1.02E+04	7.34E-09	9.31E-11	5.14E-09	1.88E-07	0	0
	Median	1.27E+02	2.06E+03	1.00E+04	1.86E-11	4.29E-11	8.99E-10	0	0	0
ABC	Best	1.56E+02	2.10E+03	6.36E+03	3.09E-02	1.00E+01	1.68E+14	1.35E-10	2.04E-11	5.57E-13
	Mean	5.13E+02	2.73E+03	7.21E+03	5.05E-01	4.85E+02	7.89E+16	1.91E-06	1.80E-07	1.57E-09
	Median	5.22E+02	2.78E+03	7.29E+03	4.36E-01	4.70E+02	4.48E+16	3.01E-07	9.96E-09	3.67E-10
BBO	Best	5.13E+02	2.52E+03	8.33E+03	2.57E-09	5.08E-10	1.05E-08	0	0	0
	Mean	1.17E+03	3.24E+03	1.09E+04	7.45E-06	1.36E-05	5.99E-04	4.88E-03	5.18E-17	0
	Median	1.19E+03	3.16E+03	1.11E+04	1.30E-07	1.65E-07	3.71E-06	0	0	0
The best result		BWO	PSO	ABC	BWO	BWO	BWO	BWO	BWO	BWO-PSO-BBO
F		F34			F35			F36		
Nvar		1	1	1	10	20	50	1	1	1
Npop		100	200	500	100	150	200	100	200	500
Maxiter		500	1500	1500	500	1000	1500	500	1500	2000
GA	Best	3.19E-146	0	0	3.29E+01	1.00E+02	2.28E+02	-2.0164	-2.0217	-2.021
	Mean	7.98E-142	0	0	2.71E+01	9.26E+01	2.07E+02	-1.9698	-1.9917	-2.0092
	Median	1.14E-143	0	0	1.70E+01	9.45E+01	2.04E+02	-1.9809	-2.0021	-2.0106
PSO	Best	1.16E-145	0	0	6.00E+01	1.20E+01	3.00E+02	-2.0218	-2.0218	-2.0218
	Mean	1.57E-136	0	0	6.00E+01	1.20E+01	2.94E+02	-2.0204	-2.0209	-2.0218
	Median	1.41E-141	0	0	6.00E+01	1.20E+01	3.00E+02	-2.0216	-2.0216	-2.0218
BWO	Best	8.38E-157	0	0	3.00E-01	1.08E-01	2.00E+00	-2.0202	-2.0196	-2.0217
	Mean	8.88E-152	0	0	2.27E-01	2.07E+00	1.77E+00	-1.9722	-1.9973	-2.0058
	Median	5.94E-153	0	0	3.00E-01	2.53E+00	1.83E+00	-1.9798	-2.0024	-2.0083
ABC	Best	1.06E-21	1.50E-21	4.85E-20	-	-	-	-2.0218	-2.0218	-2.0218
	Mean	1.46E-15	1.75E-16	2.59E-17	-	-	-	-2.0218	-2.0218	-2.0218
	Median	6.48E-17	2.77E-18	6.18E-18	-	-	-	-2.0218	-2.0218	-2.0218
BBO	Best	1.75E-156	0	0	5.09E+01	8.70E+01	1.73E+02	-2.8831	-4.6072	-5.648
	Mean	1.54E-24	1.43E-17	1.27E-40	5.26E+01	8.17E+01	1.63E+02	-2.8185	-4.538	-5.5841
	Median	5.40E-151	0	0	7.20E+01	8.20E+01	1.64E+02	-2.822	-4.5425	-5.5818

(continued on next page)

Table 3 (continued).

f		F1			F2			F3		
The best result		BWO	Except ABC	Except ABC	-	-	-	ABC	ABC	ABC
F		F37			F38			F39		
Nvar		2	2	2	2	2	2	1	1	1
Npop		100	200	500	100	200	500	100	200	500
Maxiter		500	1500	1500	500	1500	2000	500	1500	2000
GA	Best	1	1	1	-	-	-	1.04E-160	0	0
	Mean	1	1	1	-	-	-	1.42E-33	0	0
	Median	1	1	1	-	-	-	5.15E-105	0	0
PSO	Best	1	1	1	-200	-200	-200	4.87E-178	0	0
	Mean	1.00001E+00	1	1	-200	-	-200	3.00E-02	0	0
	Median	1	1	1	-200	-199.9999	-200	1.19E-02	0	0
					0	-200	0			
						std:5.63E-04				
BWO	Best	1	1	1	-200	-200	-200	1.48E-187	0	0
	Mean	1	1	1	-200	-200	-200	7.75E-48	0	0
	Median	1	1	1	-200	-200	-200	2.59E-107	0	0
					0	std:0	0			
ABC	Best	1.00E+00	1.00E+00	1.00E+00	-200	-200	-200	4.37E-15	2.48E-12	9.49E-12
	Mean	1.01E+00	1.00E+00	1.00E+00	-200	-200	-200	4.04E-09	1.43E-09	5.75E-09
	Median	1.01E+00	1.00E+00	1.00E+00	-200	-200	-200	1.37E-10	6.91E-10	3.27E-09
					4.18E-10	std:5.92E-11	1.06E-09			
BBO	Best	1	1	1	-199.99	-200	-200	3.34E-174	0	0
	Mean	1	1	1	-199.99	-200	-200	4.69E-15	0	0
	Median	1	1	1	-199.99	-200	-200	3.51E-44	0	0
					2.06E-04	std:4.18E-07	2.20E-06			
The best result		Except ABC	Except ABC	Except ABC	PSO-BWO	BWO	PSO-BWO	BWO	Except ABC	Except ABC
F		F40			F41			F42		
Nvar		1	1	1	10	20	50	10	20	50
Npop		100	200	500	100	150	200	100	150	200
Maxiter		500	1000	2000	500	1000	1500	500	1000	1500
GA	Best	-18.5547	-18.5547	-18.5547	1.41E-05	5.16E-04	7.13E-02	2.19E-07	4.28E-01	4.80E+00
	Mean	-17.7399	-18.4496	-18.5547	4.71E-02	1.15E+00	4.72E+00	1.17E+00	5.87E+00	2.27E+01
	Median	-18.5531	-18.5547	-18.5547	7.47E-03	2.71E-01	3.10E+00	2.75E-01	5.05E+00	2.11E+01
PSO	Best	-18.4961	-18.5133	-18.4897	3.07E+00	9.22E+01	2.62E+03	1.93E+01	9.48E+01	3.28E+04
	Mean	-15.1205	-16.8102	-17.7351	1.74E+01	4.28E+02	6.62E+03	7.67E+01	2.56E+03	7.26E+04
	Median	-14.8086	-16.9989	-17.8868	1.62E+01	3.91E+02	6.54E+03	5.02E+01	2.45E+03	7.45E+04
BWO	Best	-18.5547	-18.5547	-18.5547	3.80E-08	1.38E-05	6.09E-03	1.82E-08	1.14E-03	8.93E-05
	Mean	-18.5547	-18.5547	-18.5547	7.32E-03	4.32E-03	4.65E-01	2.19E-03	6.17E-01	7.26E-01
	Median	-18.5547	-18.5547	-18.5547	1.29E-04	3.57E-03	2.84E-01	2.34E-04	3.15E-02	3.76E-01
ABC	Best	-18.5547	-18.5547	-18.5547	8.95E-03	7.65E-02	5.50E+00	6.38E-01	1.78E+00	1.16E+01
	Mean	-18.5547	-18.5547	-18.5547	6.48E-02	3.35E-01	1.46E+01	1.02E+00	3.03E+00	1.83E+01
	Median	-18.5547	-18.5547	-18.5547	5.76E-02	3.42E-01	1.12E+01	1.02E+00	3.12E+00	1.83E+01
BBO	Best	-18.5547	-18.5547	-18.5547	1.35E-06	4.01E-05	7.72E-03	7.01E-03	2.55E-02	6.52E+00
	Mean	-17.0587	-17.8118	-18.45	2.09E-02	5.36E-03	3.93E-02	1.26E-02	7.04E-01	1.95E+01
	Median	-16.9847	-18.5547	-18.5547	9.96E-03	5.30E-03	3.17E-02	1.17E-02	8.52E-02	1.85E+01
The best result		BWO	BWO	BWO	BWO	BWO	BWO	BWO	BWO	BWO
F		F43			F44			F45		
Nvar		10	20	50	10	20	50	10	20	50
Npop		100	150	200	100	150	200	100	150	200
Maxiter		500	1000	1500	500	1000	1500	500	1000	1500
GA	Best	1.18E+00	9.92E+00	4.98E+01	9.99E-02	9.99E-02	2.00E-01	4.40E-01	8.68E-01	2.51E+00
	Mean	2.00E+02	7.71E+01	1.77E+02	1.53E-01	1.97E-01	3.53E-01	7.23E-01	3.73E+00	1.78E+01
	Median	5.33E+00	2.93E+01	1.09E+02	9.99E-02	2.00E-01	3.00E-01	6.95E-01	2.86E+00	1.93E+01
PSO	Best	1.04E+01	1.35E+05	1.26E+08	2.11E+00	4.96E+00	1.47E+01	4.97E-03	1.17E+00	1.23E+03
	Mean	1.38E+02	2.08E+06	7.91E+08	3.66E+00	8.79E+00	2.22E+01	9.46E+00	9.11E+01	1.84E+04
	Median	7.04E+01	1.44E+06	6.83E+08	3.77E+00	8.80E+00	2.27E+01	9.46E+00	1.95E+01	5.13E+03
BWO	Best	1.99E-01	2.75E-02	8.54E-01	9.99E-02	9.99E-02	9.98E-02	4.37E-01	6.71E-01	6.03E-01
	Mean	2.83E+00	1.49E+01	9.84E+02	1.03E-01	1.13E-01	1.76E-01	3.26E-01	1.12E+00	3.27E-01
	Median	2.18E+00	8.09E+00	1.00E+01	9.99E-02	9.99E-02	1.99E-01	4.77E-01	6.65E-01	3.56E-01

(continued on next page)

such test functions is one of the vital features of an algorithm. Hence, this group of test functions is able to benchmark the exploitation and exploration combination.

To verify the results of BWO, we adopt two famous algorithms: PSO (Poli et al., 2007) as the best swarm-based algorithm and GA (Holland, 1975) as the best evolutionary technique. Moreover, BWO algorithm

Table 3 (continued).

f		F1		F2		F3				
ABC	Best	5.44E-01	2.59E+01	2.30E+03	1.41E+00	5.37E+00	2.21E+01	2.39E-01	1.03E+00	1.91E+01
	Mean	5.85E+00	1.17E+02	4.13E+04	2.30E+00	7.87E+00	2.61E+01	5.72E-01	2.56E+00	4.50E+01
	Median	4.30E+00	1.06E+02	2.92E+04	2.30E+00	8.28E+00	2.64E+01	5.55E-01	2.50E+00	4.67E+01
BBO	Best	2.44E-02	1.32E-01	4.53E+00	9.99E-02	2.00E-01	1.10E+00	6.23E-06	3.24E-03	6.67E-01
	mean	4.85E-02	2.16E-01	6.94E+00	2.53E-01	4.37E-01	1.56E+00	5.78E-01	6.67E-01	1.36E+00
	Median	4.78E-02	2.12E-01	6.87E+00	2.00E-01	4.50E-01	1.50E+00	6.67E-01	6.68E-01	7.06E-01
The best result		BBO	BWO	BWO	BWO	BWO	BWO	BBO	BBO	BWO

Table 4

Statistical comparison of some famous benchmark functions (n = 10, MaxIter = 2000, popsize = 200, execution = 30 times).

Func	F1					F5				
Algorithm	GA	PSO	BWO	ABC	BBO	GA	PSO	BWO	ABC	BBO
Best	8.37E-11	1.16E+04	1.90E-26	9.12E-13	7.98E-29	1.15E-08	8.44E-05	5.06E-14	1.17E-01	7.27E-05
mean	9.66E-10	2.13E+05	1.18E-14	1.02E-10	7.47E-16	3.95E-02	4.43E-03	1.57E-04	3.23E-01	1.30E-04
Median	8.45E-10	1.25E+05	5.38E-19	5.72E-11	8.93E-18	3.76E-03	2.68E-03	1.71E-06	2.72E-01	1.30E-04
Worst	2.52E-09	1.09E+06	3.53E-13	3.95E-10	5.62E-15	5.05E-01	3.15E-02	1.58E-03	9.58E-01	2.01E-04
std	5.91E-10	2.27E+05	6.44E-14	1.18E-10	1.61E-15	9.63E-02	5.95E-03	3.85E-04	1.96E-01	2.94E-05
Func	F7					F8				
Algorithm	GA	PSO	BWO	ABC	BBO	GA	PSO	BWO	ABC	BBO
Best	6.28E-11	5.26E-01	0	4.12E-02	7.46E-09	2.96E-11	1.47E-02	0	3.62E-08	9.95E-01
mean	4.55E-03	7.68E-01	9.43E-04	1.09E-01	2.69E-02	1.07E-01	2.88E+00	4.24E-07	1.72E+00	4.74E+00
Median	4.61E-05	7.80E-01	4.52E-11	1.09E-01	2.09E-02	4.11E-03	2.61E+00	3.30E-07	1.49E+00	4.97E+00
Worst	2.46E-02	9.76E-01	1.26E-02	1.73E-01	9.84E-02	6.65E-01	8.63E+00	1.94E-06	3.98E+00	8.95E+00
std	6.85E-03	1.09E-01	2.97E-03	3.75E-02	2.36E-02	1.81E-01	1.82E+00	4.20E-07	1.04E+00	2.17E+00
Func	F16					F20				
Algorithm	GA	PSO	BWO	ABC	BBO	GA	PSO	BWO	ABC	BBO
Best	3.63 E-16	7.31E-08	4.18E-46	6.18E-05	6.59E-11	2.39E-12	2.09E-10	2.14E-22	4.01E-03	2.28E-07
mean	2.58E-05	1.82E-05	2.18E-09	2.15E-04	2.27E-10	1.20E-01	9.21E-07	1.63E-04	1.48E-02	5.22E-07
Median	1.84E-07	4.55E-06	3.37E-14	1.89E-04	2.06E-10	6.99E-04	5.40E-08	1.15E-08	1.46E-02	4.67E-07
Worst	7.27E-04	1.04E-04	5.74E-08	4.14E-04	5.04E-10	2.37E+00	1.19E-05	2.97E-03	3.99E-02	1.02E-06
std	1.32E-04	2.84E-05	1.01E-08	9.64E-05	1.08E-10	4.42E-01	2.60E-06	5.76E-04	9.51E-03	2.39E-07
Func	F29					F31				
Algorithm	GA	PSO	BWO	ABC	BBO	GA	PSO	BWO	ABC	BBO
Best	2.60E-12	9.59E-13	4.10E-50	9.88E-05	4.61E-09	4.15E+02	2.38E+02	7.50E+02	1.03E+02	4.74E+02
mean	1.99E-03	9.04E-09	3.20E-06	7.61E-04	1.28E-08	1.19E+03	8.73E+02	1.16E+03	3.26E+02	9.68E+02
Median	1.22E-06	4.75E-10	6.56E-11	6.53E-04	1.24E-08	1.23E+03	8.34E+02	1.14E+03	3.32E+02	9.97E+02
Worst	5.80E-02	1.62E-07	5.21E-05	1.61E-03	2.56E-08	2.05E+03	1.43E+03	1.68E+03	4.53E+02	1.52E+03
std	1.06E-02	3.00E-08	1.04E-05	4.28E-04	4.83E-09	3.67E+02	3.19E+02	2.38E+02	8.26E+01	2.78E+02

is compared with several recent algorithms such as ALO (Mirjalili, 2015b), MFO (Mirjalili, 2015a), GWO (Mirjalili et al., 2014a), WOA (Mirjalili and Lewis, 2016), SHO (Dhiman and Kumar, 2017), MVO (Mirjalili et al., 2016), and HS (Geem et al., 2001). To conduct the

Table 5

Statistical comparison of some famous benchmark functions (n = 50, MaxIter = 2000, popsize = 300, execution = 30 times).

Func	F1					F5				
Algorithm	GA	PSO	BWO	ABC	BBO	GA	PSO	BWO	ABC	BBO
Best	1.62E-30	9.93E-08	1.17E-37	1.50E-05	1.35E-17	4.63E-10	6.46E+00	2.22E-14	8.78E+00	5.53E-03
mean	4.25E-15	2.48E-04	9.65E-20	1.85E-04	8.81E-16	3.54E-02	8.58E+00	3.04E-14	1.09E+01	6.69E-03
Median	6.89E-25	6.20E-05	3.91E-21	1.08E-04	2.54E-16	6.62E-03	8.62E+00	2.93E-14	1.11E+01	6.72E-03
Worst	1.20E-13	2.90E-03	7.63E-19	6.62E-04	8.59E-15	2.22E-01	1.04E+01	4.35E-14	1.32E+01	7.88E-03
std	2.19E-14	5.58E-04	2.01E-19	1.56E-04	1.73E-15	6.06E-02	1.20E+00	6.47E-15	1.04E+00	5.83E-04
Func	F7					F8				
Algorithm	GA	PSO	BWO	ABC	BBO	GA	PSO	BWO	ABC	BBO
Best	5.14E-14	1.09E+00	0	1.01E+00	3.17E-05	1.34E-08	1.71E+02	0	9.39E+01	8.96E+00
mean	1.23E-01	1.32E+00	7.74E-03	1.08E+00	4.22E-05	8.35E-02	4.00E+02	0	1.40E+02	2.54E+01
Median	2.74E-04	1.31E+00	0	1.08E+00	4.04E-05	1.44E-03	4.13E+02	0	1.42E+02	2.49E+01
Worst	7.38E-01	1.87E+00	6.07E-02	1.15E+00	5.72E-05	8.48E-01	5.30E+02	0	1.60E+02	3.78E+01
std	2.03E-01	1.50E-01	1.69E-02	3.29E-02	6.73E-06	1.84E-01	7.74E+01	0	1.53E+01	6.91E+00
Func	F16					F20				
Algorithm	GA	PSO	BWO	ABC	BBO	GA	PSO	BWO	ABC	BBO
Best	3.01E-18	8.22E-01	6.34E-60	5.10E-02	1.84E-06	1.48E-03	1.58E+04	6.11E-20	4.34E+01	2.01E-02
mean	1.85E-04	3.59E+00	9.12E-55	1.28E-01	2.73E-06	1.03E+02	8.36E+04	1.13E+01	4.49E+02	9.63E-02
Median	1.09E-06	3.36E+00	7.87E-59	1.03E-01	2.81E-06	3.34E+01	7.09E+04	6.74E+00	3.88E+02	2.99E-02
Worst	2.41E-03	8.42E+00	2.14E-53	2.71E-01	3.98E-06	5.72E+02	2.57E+05	5.19E+01	1.62E+03	1.77E+00
std	5.81E-04	1.64E+00	3.94E-54	6.59E-02	4.43E-07	1.45E+02	5.55E+04	1.30E+01	3.26E+02	3.16E-01
Func	F29					F31				
Algorithm	GA	PSO	BWO	ABC	BBO	GA	PSO	BWO	ABC	BBO
Best	3.35E-05	1.21E+02	5.84E-07	1.57E+00	2.20E-04	1.12E+03	5.51E+03	5.42E+02	5.77E+03	3.71E+03
mean	1.29E+00	6.53E+02	1.67E-01	5.73E+00	3.83E-04	4.20E+03	8.23E+03	1.71E+03	6.84E+03	4.99E+03
Median	1.88E-07	4.56E+02	9.38E-02	5.21E+00	3.07E-04	3.77E+03	7.98E+03	1.63E+03	6.91E+03	4.93E+03
Worst	1.96E+01	1.52E+03	8.99E-01	1.48E+01	1.20E-03	7.64E+03	1.11E+04	2.82E+03	7.66E+03	7.26E+03
std	3.58E+00	4.59E+02	2.05E-01	3.08E+00	2.26E-04	1.74E+03	1.35E+03	6.62E+02	4.49E+02	9.58E+02

Table 6

p-values of the Wilcoxon rank-sum test over some benchmark functions.

F	BWO	ABC	BBO	GA	PSO
F_5	0.000181	0.472676	0.000178	0.000183	0.002827
F_7	0.000098	0.000448	0.000197	0.000183	0.002245
F_8	0.000098	0.000265	0.000368	0.000183	0.000313
F_{16}	0.000181	0.017257	0.000178	0.000183	0.000148
F_{20}	0.000221	0.002827	0.000178	0.000228	0.000202
F_{31}	0.000181	0.000178	0.000183	0.021134	0.000183

comparison, results of MFO, GWO, SHO, MVO, PSO, GA, and HS have been taken from (Dhiman and Kumar, 2017). In addition, the results of ALO and WOA have been taken from Mirjalili (2015b) and Mirjalili and Lewis (2016) respectively. Similar to the mentioned papers, BWO is run on each of the benchmark functions 30 times, and finally, in the last iteration, the average, and standard deviation of the best-estimated solution is reported.

Keeping a balance between exploitation and exploration that can prevented from getting stuck in the local optima, is very competitive task; thus, using composite benchmark functions in testing optimization algorithms is important. Owing to the massive number of local optima

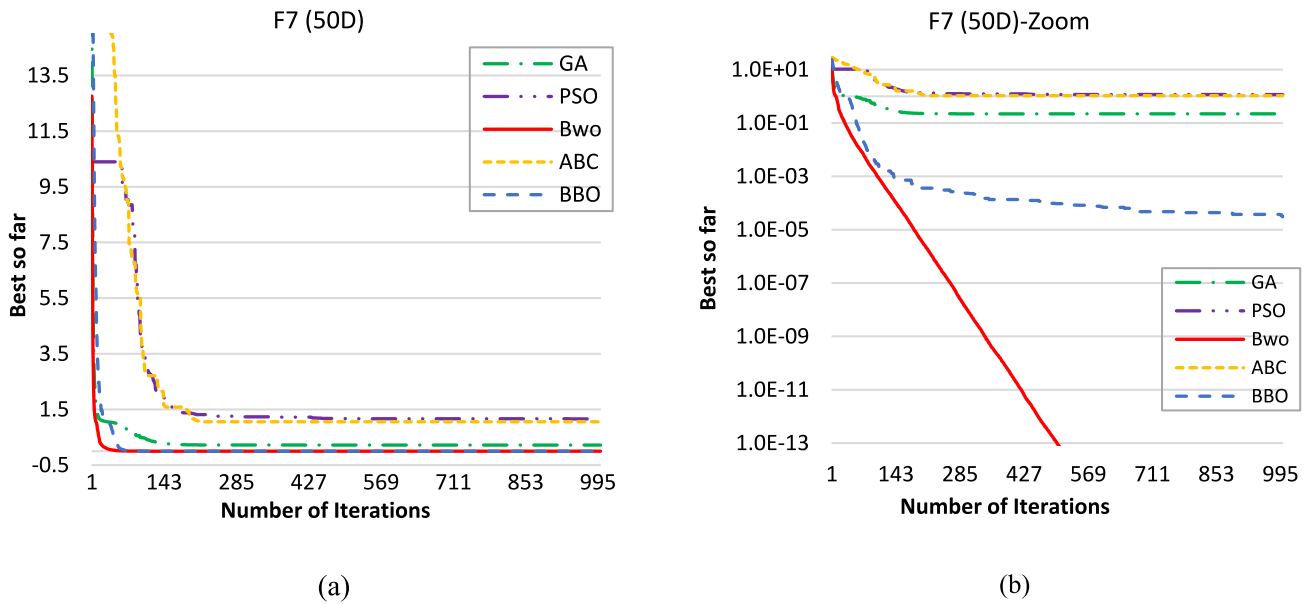

Fig. 12. (a) Convergence of F7 (n = 50), (b) Zoom to figure a.

Table 7
Comparing BWO with some well-known optimization algorithms in high dimension problems.

F	nvar	popsiz	Iter	GA	PSO	BWO	ABC	BBO
F1	100	500	1000	2.59E-16	8.78E-04	9.15E-22	3.05E-02	3.54E-15
	500	600	1500	2.59E-15	1.38E+00	1.27E-19	4.70E-01	1.16E-14
	1000	800	2000	9.32E-17	1.67E+00	1.28E-20	7.21E-01	3.67E-19
F4	100	500	1000	4.65E+02	3.95E+04	2.00E+02	9.49E+02	2.27E+03
	500	600	1500	1.19E+04	3.12E+08	2.11E+03	1.81E+08	6.63E+04
	1000	800	2000	3.39E+04	6.36E+09	5.77E+03	2.20E+09	1.86E+05
F5	100	500	1000	2.53E-01	1.00E+01	6.12E-08	1.70E+01	3.71E+00
	500	600	1500	2.00E-01	2.04E+01	6.61E-03	1.99E+01	5.16E+00
	1000	800	2000	3.42E+00	2.06E+01	4.08E-02	2.04E+01	5.13E+00
F7	100	500	1000	2.39E-03	1.62E+00	1.33E-13	9.46E-01	4.09E-04
	500	600	1500	1.51E-01	4.66E+00	2.15E-04	1.89E+00	5.77E-02
	1000	800	2000	5.95E+00	8.57E+00	1.27E-02	4.06E+00	6.47E+00
F8	100	500	1000	4.43E+00	4.39E+02	2.49E-13	4.71E+02	2.25E+02
	500	600	1500	2.36E+02	6.49E+03	1.36E-02	4.27E+03	2.05E+03
	1000	800	2000	8.71E+02	1.38E+04	1.20E+00	1.08E+04	3.57E+03
F16	100	500	1000	7.19E-03	2.40E+01	1.10E-05	1.79E-02	4.79E-01
	500	600	1500	1.62E+00	1.98E+03	9.56E-03	3.68E+02	1.03E+01
	1000	800	2000	5.83E+00	4.45E+03	2.21E-01	2.14E+03	1.84E+01
F29	100	500	1000	1.00E+00	5.24E+03	2.82E-03	1.06E+03	6.33E+01
	500	600	1500	1.21E+03	1.64E+06	9.64E+00	9.17E+05	9.20E+03
	1000	800	2000	8.60E+03	8.13E+06	2.99E+02	5.12E+06	3.62E+04

in these test functions, the feature of escaping from local optima of an algorithm can be verified by testing the algorithm with these functions.

Considering Table 10, it can be observed that the BWO algorithm has proved its superiority in all cases except F46, in which our proposed algorithm acted very competitive. Fig. 20 shows the convergence curves of BWO to display the convergence rate of the BWO algorithm. It should be mentioned that the best score refers to the mean of the best solution achieved over 30 runs in each iteration. Moreover, Table 11 demonstrates the p-Values which verify that superiority is remarkable in almost all of the functions. This superiority can prove the high exploration capability of the proposed algorithm, which helps it to search for the promising areas of the search domain.

5. BWO for classical engineering problems

In this section, we adopt pressure vessel designs, welded beam, and tension/compression spring problems, which are constrained engineering design problems and have some equality and inequality limitations. Thus, in order to optimize constrained problems by BWO, it should be equipped with a method to be able to deal with constraints as well. In order to prove the superiority of the proposed algorithm, similar to the previous section, we have compared the results of BWO with some classic famous algorithms and also with some recent ones. Aiming to conduct the comparison, results of MFO, GWO, SHO, MVO, PSO, GA, and HS have been taken from Dhiman and Kumar

Table 8
The results of convergence experiments.

Function		GA	PSO	BWO	ABC	BBO
10 Dimensional	F4	10.3602	7.868104	7.662559	9.204979	7.901309
	F5	0.005321	0.000526	3.11E-10	2.23071	0.002693
	F7	0.010326	0.196862	6.42E-13	0.149069	0.019691
	F8	6.15E-05	6.88973	2.82E-05	6.025946	1.989921
	F16	1.56E-05	0.004102	4.66E-12	0.000265	2.22E-07
50 Dimensional	F4	1910.659	3104.306494	48.29860644	610.933218	49.21780332
	F5	0.022629	9.043863	2.22E-14	11.34636	0.010613
	F7	0.219918	1.161192	0	1.057348	3.06E-05
	F8	0.253252	270.6246	0	129.234	19.89969
	F16	3.59E-17	1.519369	3.34E-31	0.097035	5.92E-06

Table 9
Composite benchmark functions.

Function	Dimension	Range	f_{min}
F_{46} (CF1) : $f_1, f_2, f_3, \dots, f_{10} = \text{Sphere Function}$ $[\delta_1, \delta_2, \delta_3, \dots, \delta_{10}] = [1, 1, 1, \dots, 1]$ $[\lambda_1, \lambda_2, \lambda_3, \dots, \lambda_{10}] = [5/100, 5/100, 5/100, \dots, 5/100]$	10	[-5, 5]	0
F_{47} (CF2) : $f_1, f_2, f_3, \dots, f_{10} = \text{Griewank's Function}$ $[\delta_1, \delta_2, \delta_3, \dots, \delta_{10}] = [1, 1, 1, \dots, 1]$ $[\lambda_1, \lambda_2, \lambda_3, \dots, \lambda_{10}] = [5/100, 5/100, 5/100, \dots, 5/100]$	10	[-5, 5]	0
F_{48} (CF3) : $f_1, f_2, f_3, \dots, f_{10} = \text{Griewank's Function}$ $[\delta_1, \delta_2, \delta_3, \dots, \delta_{10}] = [1, 1, 1, \dots, 1]$ $[\lambda_1, \lambda_2, \lambda_3, \dots, \lambda_{10}] = [1, 1, 1, \dots, 1]$	10	[-5, 5]	0
F_{49} (CF4) : $f_1, f_2 = \text{Ackley's Function}$ $f_3, f_4 = \text{Rastrigin's Function}$ $f_5, f_6 = \text{Weierstrass Function}$ $f_7, f_8 = \text{Griewank's Function}$ $f_9, f_{10} = \text{Sphere Function}$ $[\delta_1, \delta_2, \delta_3, \dots, \delta_{10}] = [1, 1, 1, \dots, 1]$ $[\lambda_1, \lambda_2, \lambda_3, \dots, \lambda_{10}] = [5/32, 5/32, 1, 1, 5/0.5, 5/0.5, 5/100, 5/100, 5/100, 5/100]$	10	[-5, 5]	0
F_{50} (CF5) : $f_1, f_2 = \text{Rastrigin's Function}$ $f_3, f_4 = \text{Weierstrass Function}$ $f_5, f_6 = \text{Griewank's Function}$ $f_7, f_8 = \text{Ackley's Function}$ $f_9, f_{10} = \text{Sphere Function}$ $[\delta_1, \delta_2, \delta_3, \dots, \delta_{10}] = [1, 1, 1, \dots, 1]$ $[\lambda_1, \lambda_2, \lambda_3, \dots, \lambda_{10}] = [1/5, 1/5, 5/0.5, 5/0.5, 5/100, 5/100, 5/32, 5/32, 5/100, 5/100]$	10	[-5, 5]	0
F_{51} (CF6) : $f_1, f_2 = \text{Rastrigin's Function}$ $f_3, f_4 = \text{Weierstrass Function}$ $f_5, f_6 = \text{Griewank's Function}$ $f_7, f_8 = \text{Ackley's Function}$ $f_9, f_{10} = \text{Sphere Function}$ $[\delta_1, \delta_2, \delta_3, \dots, \delta_{10}] = [0.1, 0.2, 0.3, 0.4, 0.5, 0.6, 0.7, 0.8, 0.9, 1]$ $[\lambda_1, \lambda_2, \lambda_3, \dots, \lambda_{10}] = [0.1 * 1/5, 0.2 * 1/5, 0.3 * 5/0.5, 0.4 * 5/0.5, 0.5 * 5/100, 0.6 * 5/100, 0.7 * 5/32, 0.8 * 5/32, 0.9 * 5/100, 1 * 5/100]$	10	[-5, 5]	0

(2017). In addition, the results WOA have been taken from Mirjalili and Lewis (2016) directly. Various kinds of penalty functions such as

annealing, co-evolutionary, dynamic, static, and death penalty are used in constrained optimization problems (Wang et al., 2011).

Table 10
Results of composite benchmark functions.

F	BWO		MFO		ALO		GWO		WOA	
	Ave	Std.	Ave	Std.	Ave	Std.	Ave	Std.	Ave	Std.
F ₄₆	9.91E-01	2.91E+00	1.18E+02	7.40E+01	1.51E-04	3.82E-04	8.39E+01	8.42E+01	5.68E-01	5.06E-01
F ₄₇	8.81E-04	0	9.20E+01	1.36E+02	1.46E+01	3.22E+01	1.48E+02	3.78E+01	7.53E+01	4.31E+01
F ₄₈	2.24E-02	1.91E-03	4.19E+02	1.15E+02	1.75E+02	4.65E+01	3.53E+02	5.88E+01	5.57E+01	2.19E+01
F ₄₉	3.98E-01	1.04E-03	3.31E+02	2.09E+01	3.16E+02	1.30E+01	4.23E+02	1.14E+02	5.38E+01	2.16E+01
F ₅₀	3.00E+00	0	1.13E+02	9.27E+01	4.39E+00	1.66E+00	1.36E+02	2.13E+02	7.78E+01	5.20E+01
F ₅₁	1.45E+01	1.31E-02	8.92E+02	2.41E+01	5.00E+02	2.07E-01	8.26E+02	1.74E+02	5.79E+01	3.44E+01

F	PSO		GA		SHO		MVO		HS	
	Ave	Std.	Ave	Std.	Ave	Std.	Ave	Std.	Ave	Std.
F ₄₆	6.00E+01	8.94E+01	5.97E+02	1.34E+02	2.30E+02	1.37E+02	1.40E+02	1.52E+02	4.37E+01	2.09E+01
F ₄₇	2.44E+02	1.73E+02	4.09E+02	2.10E+01	4.08E+02	9.36E+01	2.50E+02	1.44E+02	1.30E+02	3.34E+00
F ₄₈	3.39E+02	8.36E+01	9.30E+02	8.31E+01	3.39E+02	3.14E+01	4.05E+02	1.67E+02	5.07E+02	4.70E+01
F ₄₉	4.49E+02	1.42E+02	4.97E+02	3.24E+01	7.26E+02	1.21E+02	3.77E+02	1.28E+02	3.08E+02	2.07E+02
F ₅₀	2.40E+02	4.25E+02	1.90E+02	5.03E+01	1.06E+02	1.38E+01	2.45E+02	9.96E+01	8.43E+02	6.94E+02
F ₅₁	8.22E+02	1.80E+02	6.65E+02	3.37E+02	5.97E+02	4.98E+00	8.33E+02	1.68E+02	7.37E+02	2.76E+01

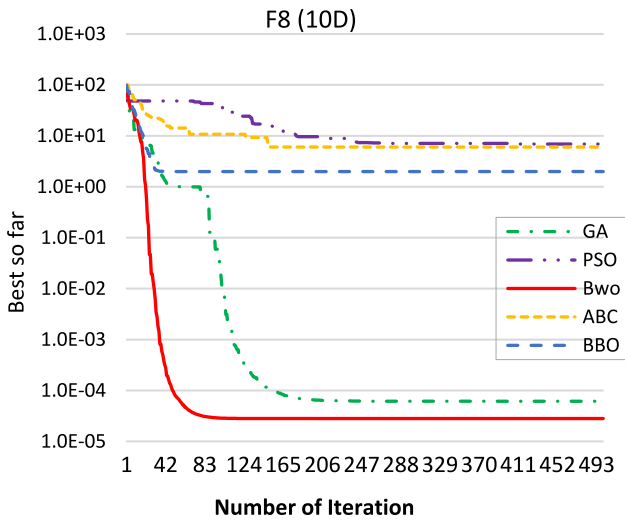

Fig. 13. Convergence of F8 (n = 10).

5.1. Pressure vessel design

This problem aims to reduce the total cost of a cylinder-shaped pressure vessel which is shown in Fig. 21 (Dong et al., 2014) including material, welding, and forming. The head of the vessel is in the shape of a hemispherical whereas both ends of it are capped. The optimization variable consists of the thickness of the head (T_h), the thickness of the shell (T_s), the length of the cylindrical section without considering the head (L), the inner radius (R). There are four optimization constraints and is formulated as follows:

Consider $\vec{x} = [x_1 \ x_2 \ x_3 \ x_4] = [T_s \ T_h \ R \ L]$
 Minimize $f(\vec{x}) = 0.6224x_1x_3x_4 + 1.7781x_2x_3^2 + 3.1661x_1^2x_4 + 19.84x_1^2x_3$
 Subject to: $g_1(\vec{x}) = -x_1 + 0.0193x_3 \leq 0$,
 $g_2(\vec{x}) = -x_3 + 0.00954x_4 \leq 0$,
 $g_3(\vec{x}) = -\pi x_3^2x_4 - \frac{4}{3}\pi x_3^3 + 1,296,000 \leq 0$,
 $g_4(\vec{x}) = x_4 - 240 \leq 0$,
 Variable Range: $0 \leq x_1 \leq 99$,

Table 11
p-Values of the Wilcoxon rank-sum test over composite benchmark functions.

F	BWO	MFO	ALO	GWO	MVO	GA	PSO
F ₄₆	0.000163	N/A	N/A	0.001315	0.064022	0.000172	0.000172
F ₄₇	0.000163	0.002202	N/A	0.000583	0.472676	0.000183	0.677585
F ₄₈	0.000163	N/A	N/A	0.005877	0.064022	0.000183	0.000181
F ₄₉	0.000172	0.000186	N/A	0.007285	0.045155	0.000189	0.088973
F ₅₀	0.000172	N/A	N/A	0.384673	0.021134	0.000183	0.045155
F ₅₁	0.000163	0.241322	N/A	0.088973	0.01133	N/A	0.088973

$0 \leq x_2 \leq 99$,
 $10 \leq x_3 \leq 200$,
 $10 \leq x_4 \leq 200$,

Many researchers have solved this test case using various meta-heuristic techniques such as GA (Coello and Montes, 2002; Coello, 2000; Deb, 1997), PSO (He and Wang, 2007), DE (Li et al., 2007), ACO (Kaveh and Talatahari, 2010b), improved HS (Mahdavi et al., 2007), and ES (Mezura-Montes and Coello Coello, 2008). Moreover, some have applied mathematical techniques such as branch-and-bound (Sandgren, 1990) and Lagrangian multiplier (Kannan and Kramer, 1994). The comparison of the best optimal solutions for BWO and methods as mentioned earlier are represented in Table 12. Considering this table, it could be concluded that BWO can reach the optimal design with the lowest amount of cost. Table 13 presents the statistical results of resolving the pressure design problem by those algorithms. According to the results, BWO outperforms all other algorithms in terms approaching to the optimal solution.

5.2. Welded beam design

In this problem, the objective is minimizing the production cost of the welded beam presented in Fig. 22 (Dong et al., 2014). Optimization variables of this test problem including the thickness of the bar (b), the thickness of weld (h), the height of the bar (t), and length of the clamped bar (l). There are four optimization constraints on shear stress (τ), and bending stress in the beam (θ), end deflection of the beam (δ), buckling load (P_c). The optimization problem is formulated mathematically as follows:

Consider $\vec{x} = [x_1 \ x_2 \ x_3 \ x_4] = [h \ l \ t \ b]$,
 Minimize $f(\vec{x}) = 1.10471x_1^2x_2 + 0.04811x_3x_4(14.0 + x_2)$,

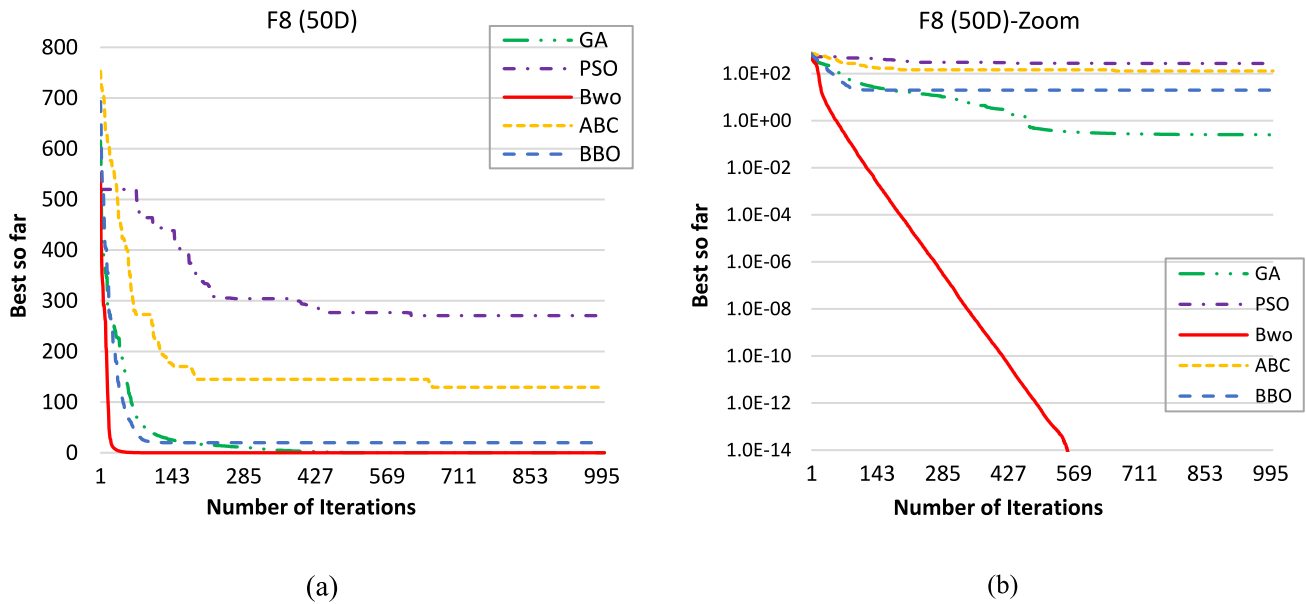

Fig. 14. (a) Convergence of F8 (n = 50), (b) Zoom to figure a.

Table 12 Comparison results for pressure vessel design problem.

Algorithms	Optimum variables				Optimum cost
	T_s	T_h	R	L	
BWO	0.777821	0.373174	39.9973587	199.93614	5796.0389
GA	0.752362	0.399540	40.452514	198.00268	5890.3279
PSO	0.778961	0.384683	40.320913	200.00000	5891.3879
MFO	0.835241	0.409854	43.578621	152.21520	6055.6378
MVO	0.845719	0.418564	43.816270	156.38164	6011.5148
GWO	0.779035	0.384660	40.327793	199.65029	5889.3689
SHO	0.778210	0.384889	40.315040	200.00000	5885.5773
WOA	0.812500	0.437500	42.0982699	176.638998	6059.7410
HS	1.099523	0.906579	44.456397	179.65887	6550.0230

$$g_4(\vec{x}) = x_1 - x_4 \leq 0,$$

$$g_5(\vec{x}) = P - P_c(\vec{x}) \leq 0,$$

$$g_6(\vec{x}) = 0.125 - x_1 \leq 0,$$

$$g_7(\vec{x}) = 1.10471x_1^2 + 0.04811x_3x_4(14.0 + x_2) - 5.0 \leq 0,$$

Variable range : $0.05 \leq x_1 \leq 2.00,$
 $0.25 \leq x_2 \leq 1.30,$
 $2.00 \leq x_3 \leq 15.0,$

Best solution attained by BWO and other algorithms mentioned above are compared in Table 14. The results indicate that the best design is obtained by BWO. Table 15 presents the statistical comparison results for those algorithms. It demonstrates that BWO achieves better results in all cases and also aiming to reach to the best optimal solution, it needs less amount of investigates.

5.3. Tension/compression spring design problem

Minimizing the weight of a tension/compression spring shown in Fig. 23 (Dong et al., 2014), is the goal of this design problem. There are three constraints in the process of minimization, including surge frequency, minimum deflection, and shear stress. This issue has some variables such as mean coil diameter (D), the number of active coils (N), and wire diameter (d). The problem is formulated mathematically as follows:

Consider $\vec{x} = [x_1 \ x_2 \ x_3 \ x_4] = [d \ D \ N]$,

Minimize $f(\vec{x}) = (x_3 + 2)x_2x_1^2$,

Subject to : $g_1(\vec{x}) = 1 - \frac{x_2^3x_3}{71785x_1^4} \leq 0,$

$$g_2(\vec{x}) = \frac{4x_2^2 - x_1x_2}{12566(x_2x_1^3 - x_1^4)} + \frac{1}{5108x_1^2} \leq 0,$$

$$g_3(\vec{x}) = 1 - \frac{140.45x_1}{x_2^2x_3} \leq 0,$$

$$g_4(\vec{x}) = \frac{x_1 + x_2}{1.5} - 1 \leq 0$$

Various optimization methods, such as GA, PSO, GWO, MFO, MVO, SHO, WOA, and HS, have investigated this problem. Table 16 demonstrates the result of the comparison for the best optimal solution attained by these algorithms. The superiority of BWO in achieving the

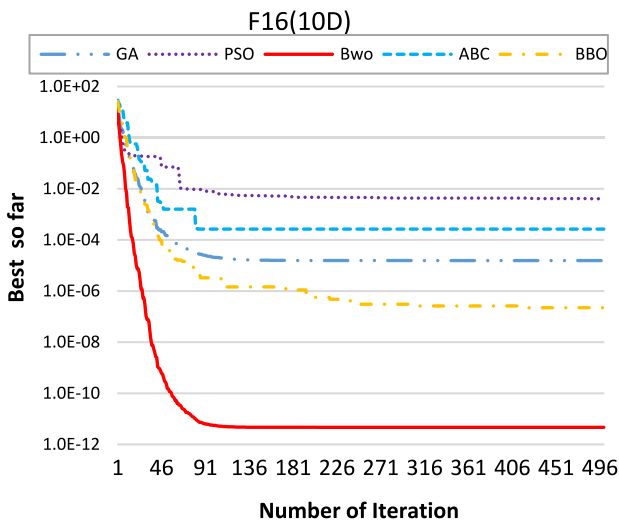

Fig. 15. Convergence of F16 (n = 10).

Subject to

$$g_1(\vec{x}) = \tau(\vec{x}) - \tau_{max} \leq 0,$$

$$g_2(\vec{x}) = \sigma(\vec{x}) - \sigma_{max} \leq 0,$$

$$g_3(\vec{x}) = \delta(\vec{x}) - \delta_{max} \leq 0,$$

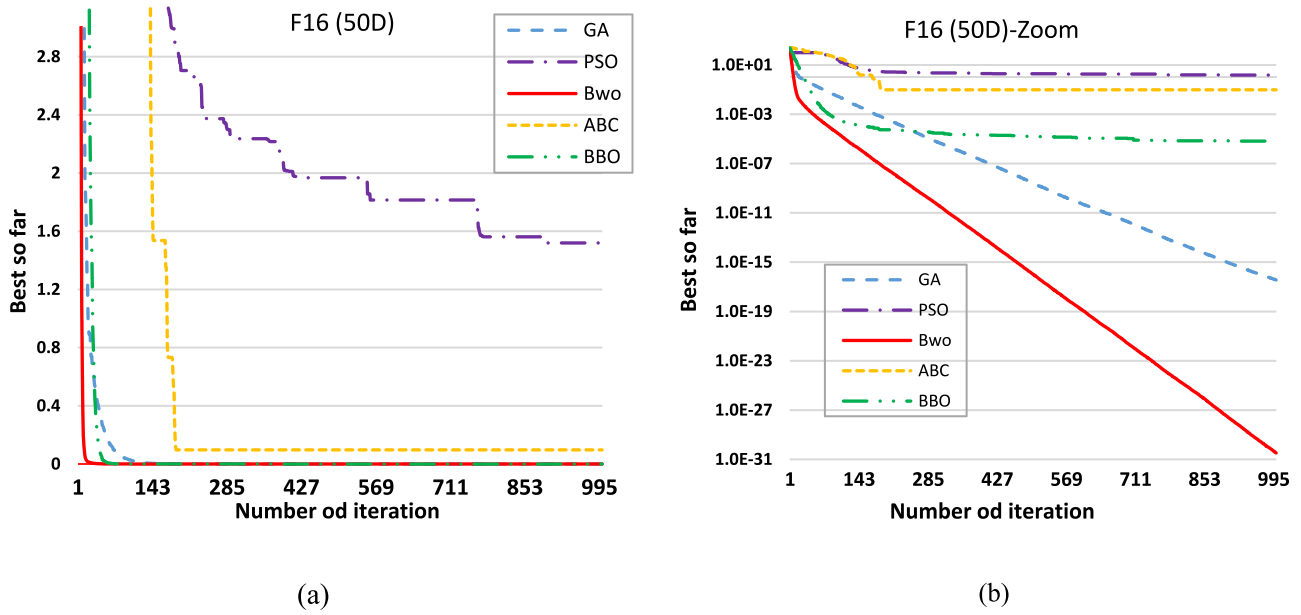

Fig. 16. (a) Convergence of F16 (n = 50), (b) Zoom to figure a.

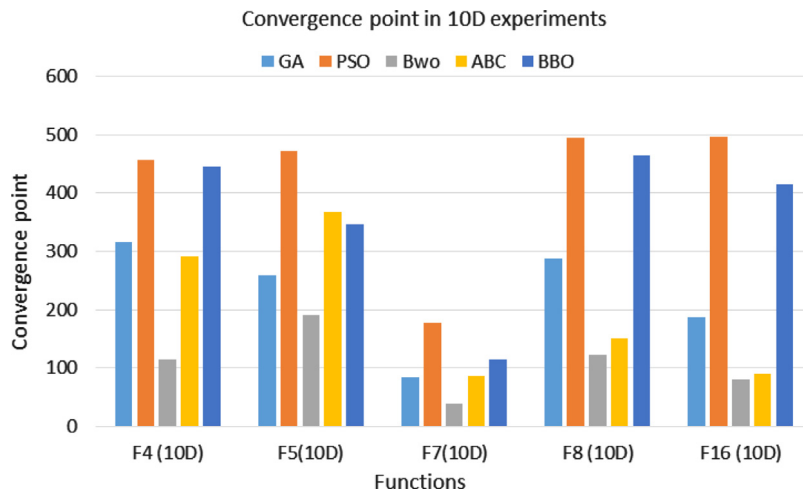

Fig. 17. The convergence point of the experimental algorithms in 10D experiments.

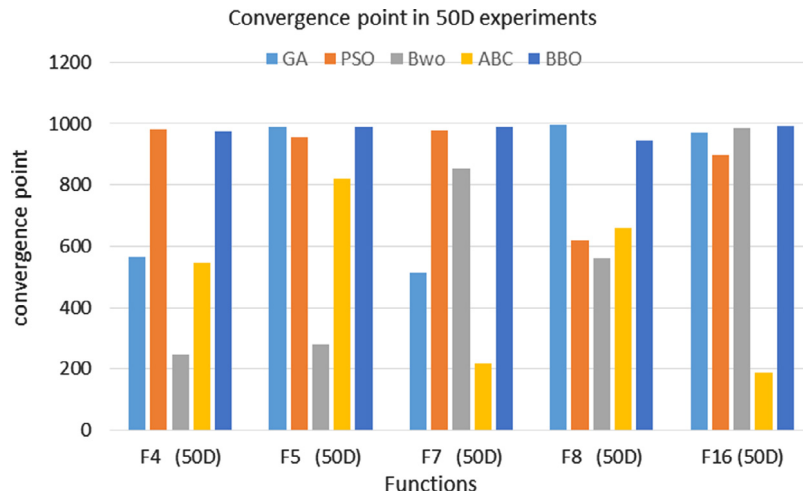

Fig. 18. The convergence point of the experimental algorithms in 50D experiments.

Table 13
Comparison of BWO statistical for the pressure vessel design problem.

AlgorithmsBest	Mean	Worst	Std. Dev.	Median	
	5796.0389	5799.0214	5801.2113	002.073	5798.4326
BWO					
GA	5890.3279	6264.0053	7005.7500	496.128	6112.6899
PSO	5891.3879	6531.5032	7394.5879	534.119	6416.1138
MFO	6055.6378	6360.6854	7023.8521	365.597	6302.2301
MVO	6011.5148	6477.3050	7250.9170	327.007	6397.4805
GWO	5889.3689	5891.5247	5894.6238	013.910	5890.6497
SHO	5885.5773	5887.4441	5892.3207	002.893	5886.2282
WOA	6059.7410	6068.05	N/A	65.6519	N/A
HS	6550.0230	6643.9870	8005.4397	657.523	7586.0085

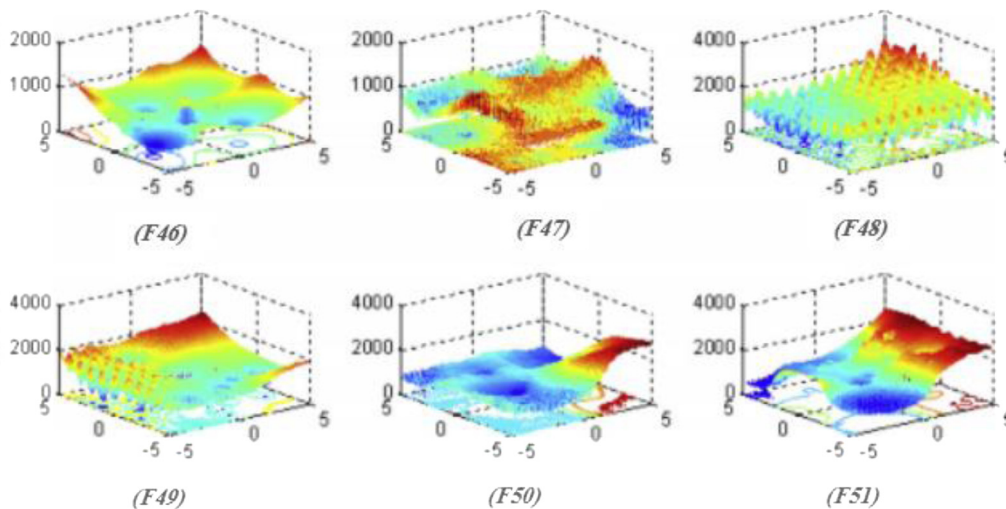

Fig. 19. 2-D versions of composite benchmark functions.

Table 14
Comparison results for welded beam design.

Algorithms	Optimum variables				Optimum cost
	h	t	l	b	
BWO	0.198694	3.421708	9.028637	0.200138	1.663761
GA	0.164171	4.032541	10.00000	0.223647	1.873971
PSO	0.197411	3.315061	10.00000	0.201395	1.820395
MFO	0.203567	3.443025	9.230278	0.212359	1.732541
MVO	0.205611	3.472103	9.040931	0.205709	1.725472
GWO	0.205678	3.475403	9.036964	0.206229	1.726995
SHO	0.205563	3.474846	9.035799	0.205811	1.725661
WOA	0.205396	3.484293	9.037426	0.206276	1.730499
HS	0.206487	3.635872	10.00000	0.203249	1.836250

of tension/compression spring design applied to the aforementioned optimization methods. The results prove that BWO attains better results and needs less amount of examines aiming to reach to the best optimal design.

5.4. Summary of classical engineering problems' experiments

In this subsection, we select three algorithms to show the summary of the classical engineering problems' experiments. In Table 18, three above-mentioned design problems, three selected algorithms, and their relevant results are illustrated. It is crystal clear that the proposed BWO algorithm outperforms the other three algorithms including GA, PSO, and MVO.

6. Discussion

Large numbers of bio-inspired meta-heuristic algorithms have been proposed for different optimization problems. This paper introduced

optimal solution can be concluded from the results shown in Table 16. Besides, Table 17 presents the results of the statistical comparison

Table 15
Comparison of BWO statistical for the welded beam design problem.

AlgorithmsBest	Mean	Worst	Std. Dev.	Median	
	1.663761	1.665621	1.664165	0.000279	1.663885
BWO					
GA	1.873971	2.119240	2.320125	0.034820	2.097048
PSO	1.820395	2.230310	3.048231	0.324525	2.244663
MFO	1.732541	1.775231	1.802364	0.012397	1.812453
MVO	1.725472	1.729680	1.741651	0.004866	1.727420
GWO	1.726995	1.727128	1.727564	0.001157	1.727087
SHO	1.725661	1.725828	1.726064	0.000287	1.725787
WOA	1.730499	1.7320	N/A	0.0226	N/A
HS	1.836250	1.363527	2.035247	0.139485	1.9357485

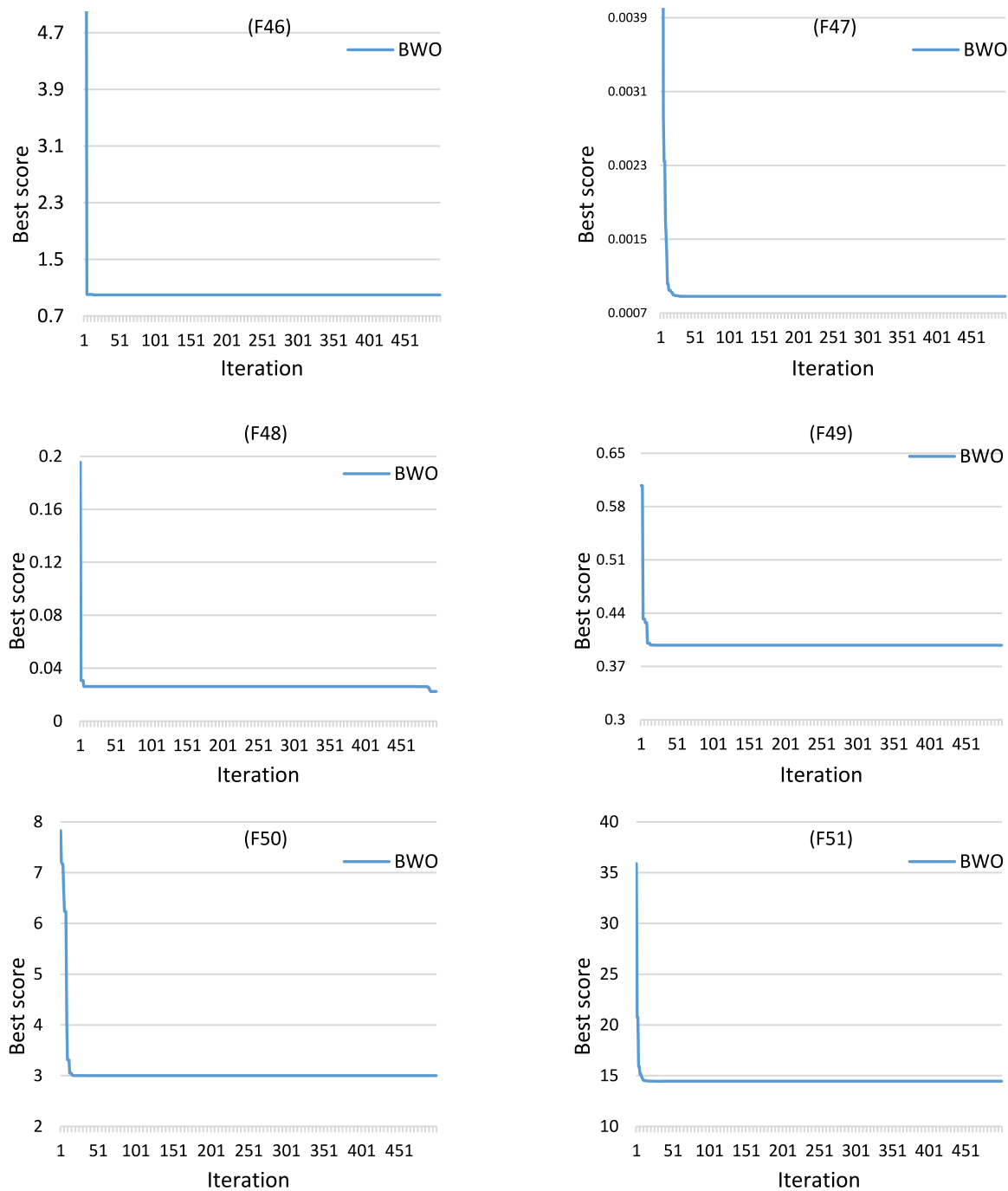

Fig. 20. Convergence curves of BWO obtained in composite benchmark problems.

a new bio-inspired meta-heuristic algorithm, called BWO, which is inspired by the mating behavior of black widow spiders. Experimental results of BWO have been investigated in various scales and have been compared to the four well-known algorithms including GA (Genetic Algorithm), PSO (Particle Swarm Optimization), ABC (Artificial Bee Colony) and BBO (Biography Based Optimization) and some recent ones such as ALO, WOA, MFO, GWO, SHO, MVO. Table 3 shows the results of 10, 20, and 50-dimensional experiments, each of which has been run 30 times. According to the results of Table 3, it is clearly seen that in most of the cases BWO has been able to overcome other algorithms and also it has reached to almost the global minima of the test functions. In other words, BWO has spectacularly outperformed and also has obtained an excellent estimation of the exact global optima. BWO has found the exact global optima with acceptable accuracy in 13

different inclusive test functions F6, F7, F8, F15, F23, F27, F30, F33, F34, F37, F38, F39, and F40. Moreover, almost acceptable results were obtained in other functions.

Tables 4, 5 represent the results of statistical experiments in dimensions 10 and 50, respectively. According to the results, it seems that increasing problems' scale and also the population size did not reduce the quality of BWO's results. Table 7 demonstrates the comparison of the proposed algorithm with other experimental algorithms for large-scale problems in which BWO is performed remarkably well. Then all of the experimental algorithms are compared in the case of convergence with different well-known benchmark functions, and the results are depict in Table 8 and also some other Figures. All of these results show that BWO can be employed for various optimization problems.

Table 16
Comparison results for Tension/compression spring design problem.

Algorithms	Optimum variables			Optimum cost
	d	D	N	
BWO	0.051066	0.342967	12.091428	0.012602915
GA	0.05010	0.310111	14.0000	0.013036251
PSO	0.05000	0.310414	15.0000	0.013192580
MFO	0.05000	0.313501	14.03279	0.012753902
MVO	0.05000	0.315956	14.22623	0.012816930
GWO	0.050178	0.341541	12.07349	0.012678321
SHO	0.051144	0.343751	12.0955	0.012674000
WOA	0.051207	0.345215	12.004032	0.0126763
HS	0.05025	0.316351	15.23960	0.012776352

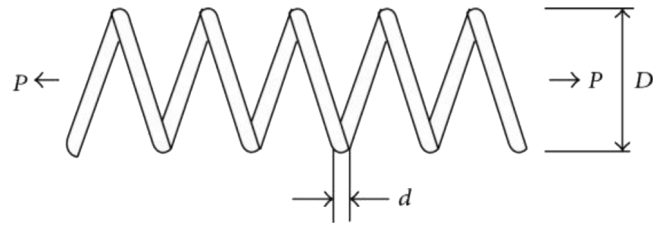

Fig. 23. Tension/compression spring design problem.

Due to the results, it seems that BWO is capable of finding almost the exact optima solutions for most of the benchmark functions even in large-scale problems. Considering the acceptable results in different benchmark functions, it can be applied to various optimization problems.

Moreover, three classical engineering problems are solved using BWO algorithm. The results of BWO were compared to two well-known and some of the recent algorithms in the literature. This comparison points out that the BWO algorithm has the potential of handling different combinatorial optimization problems and is able to optimize the real problems with unknown search space as well.

Since the proposed algorithm is an evolutionary algorithm, it will involve the discussing of new generation production. Keeping this fact in mind, the similarity between the BWO and GA will not be an unexpected case, since GA is a base structure for most of the evolutionary algorithms. However, there are remarkable differences between BWO and GA. In the process of producing a new generation in the BWO algorithm, the number of offspring is equal to $N_{var}/2$, while in GA, only two descendants are generated. The higher the number of offspring, the more chance of discovering a larger amount of the search space, which will ensure the obtaining of high performance for the exploration stage, and as a result, the proposed algorithm will be able to escape from the local optima problem. Furthermore, the cannibalism operator provides the ability to eliminate improper solutions immediately. Consequently, the next generation will be reproduced by the better parents, which guarantees the fast convergence of the solutions nearby the optimal solutions. This feature is known as exploitation. The proposed BWO provides a proper balance between exploration and exploitation stages, which is one of the most critical features of the meta-heuristic algorithms. Considering the argument above, the proposed algorithm is able to obtain outstanding results in comparison with other experimental algorithms, especially compared to GA.

The proposed BWO algorithm can be applied to various kind of engineering optimization problems such as feature selection (Abualigah, 2019), information retrieval (Abualigah and Hanandeh, 2015), text clustering (Abualigah and Khader, 2017), hybrid clustering analysis (Abualigah et al., 2018c), text document clustering analysis (Abualigah et al., 2018a), document clustering (Abualigah et al., 2018b), clustering techniques (Abualigah et al., 2017), optimization in cloud computing

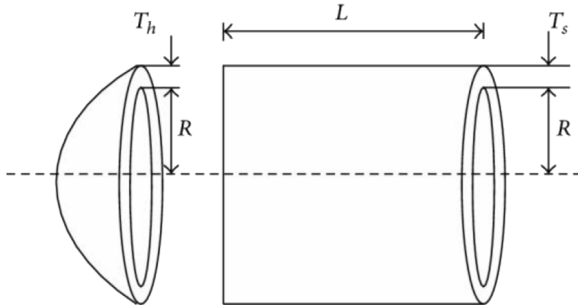

Fig. 21. Pressure vessel design problem.

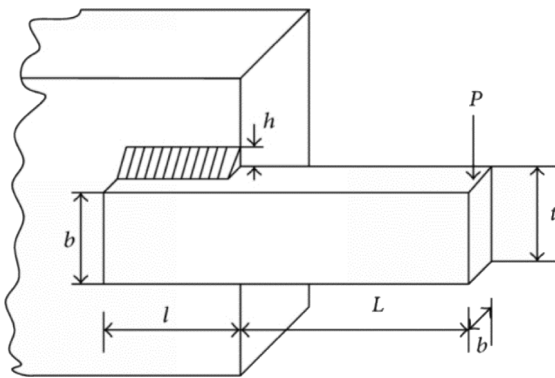

Fig. 22. Welded beam design problem.

Additionally, BWO is applied to some composite benchmark functions which are shown in Table 9. The results are compared to the other algorithms. Table 10 presents the results. By observing this table, it can be concluded that the BWO algorithm performs the others except in the case of F46.

Table 17
Comparison of BWO statistical for the Tension/compression spring design problem.

Algorithms	Best	Mean	Worst	Std. Dev.	Median
BWO	0.012602915	0.012613028	0.012642131	0.000026	0.012613447
GA	0.013036251	0.014036254	0.016251423	0.002073	0.013002365
PSO	0.013192580	0.014817181	0.017862507	0.002272	0.013192580
MFO	0.012753902	0.014023657	0.017236590	0.001390	0.013896512
MVO	0.012816930	0.014464372	0.017839737	0.001622	0.014021237
GWO	0.012678321	0.012697116	0.012720757	0.000041	0.012699686
SHO	0.012674000	0.012684106	0.012715185	0.000027	0.012687293
WOA	0.0126763	0.0127	N/A	0.0003	N/A
HS	0.012776352	0.013069872	0.015214230	0.000375	0.012952142

Table 18
The summary of classical engineering problems' experiments.

The problem name	BWO	GA	PSO	MVO
Pressure vessel design	5796.0389	5890.3279	5891.3879	6011.5148
Welded beam design	1.663761	1.873971	1.820395	1.725472
Tension/compression spring design problem	0.012602915	0.013036251	0.013192580	0.012816930

(Hayyolalam and Pourhaji Kazem, 2018), optimization in IoT (Pourghebleh and Hayyolalam, 2019; Pourghebleh and Navimipour, 2017), and so forth.

Briefly speaking, with regards to the outcomes of this research, the following cases can be concluded:

- Randomly selecting the parents for procreate step ensures the exploration of the search domain.
- Producing numerous offspring in procreate step put emphasis on the exploration of the search domain as well.
- The procreate step helps the BWO algorithm to overcome the local optima trap.
- Escaping from local optima is remarkable in the BWO algorithm since it adopts numerous search agents to estimate the global optima.
- Cannibalism step by omitting the improper solutions aids the BWO algorithm to move toward the best solution very fast.
- The cannibalism step guarantees the high performance of the exploitation, which ensures the fast convergence of the BWO algorithm.
- The mutation step confirms the balance between the exploitation and exploration stages.

7. Conclusions

This paper proposed a novel meta-heuristic optimization algorithm, which was inspired by the bizarre mating behavior of black widow spiders. The Special characteristic of black widows in mating and reproducing new generation had been the main motivation for the development of this new algorithm. The proposed algorithm was investigated by 51 benchmark functions and also three real engineering design problems in order to illustrate the performance of the introduced algorithm. The comparison of BWO with some other well-known or recent indicated that BWO has remarkably high performance in finding the real global optima with a high level of accuracy and with fast convergence. However, it should be mentioned that although BWO has an outstanding performance for these 51 benchmark functions and three engineering problems as well, it does not mean that BWO is the best optimization algorithm ever developed. It can be considered as an appropriate and suitable algorithm for various optimization problems.

References

Abualigah, Laith Mohammad Qasim, 2019. Feature Selection and Enhanced Krill Herd Algorithm for Text Document Clustering. Springer.

Abualigah, Laith Mohammad Qasim, Hanandeh, Essam S., 2015. Applying genetic algorithms to information retrieval using vector space model. *Int. J. Comput. Sci., Eng. Appl.* 5 (1), 19.

Abualigah, Laith Mohammad, Khader, Ahamad Tajudin, 2017. Unsupervised text feature selection technique based on hybrid particle swarm optimization algorithm with genetic operators for the text clustering. *J. Supercomput.* 73 (11), 4773–4795.

Abualigah, Laith Mohammad, Khader, Ahamad Tajudin, Hanandeh, Essam Said, 2018a. A combination of objective functions and hybrid krill herd algorithm for text document clustering analysis. *Eng. Appl. Artif. Intell.* 73, 111–125.

Abualigah, Laith Mohammad, Khader, Ahamad Tajudin, Hanandeh, Essam Said, 2018b. A new feature selection method to improve the document clustering using particle swarm optimization algorithm. *J. Comput. Sci.* 25, 456–466.

Abualigah, Laith Mohammad, Khader, Ahamad Tajudin, Hanandeh, Essam Said, 2018c. Hybrid clustering analysis using improved krill herd algorithm. *Appl. Intell.* 48 (11), 4047–4071.

Abualigah, Laith Mohammad, Khader, Ahamad Tajudin, Hanandeh, Essam Said, Gandomi, Amir H., 2017. A novel hybridization strategy for krill herd algorithm applied to clustering techniques. *Appl. Soft Comput.* 60, 423–435.

Alami, J., Imrani, A.El, 2008. Dielectric composite multimodal optimization using a multipopulation cultural algorithm. *Intell. Data Anal.* 12 (4), 359–378.

Andrade, Maydianne C.B., 1996. Sexual selection for male sacrifice in the Australian redback spider. *Science* 271 (5245), 70–72, Retrieved (<http://science.sciencemag.org/content/271/5245/70>).

Andrade, Maydianne C.B., 1998. Female hunger can explain variation in cannibalistic behavior despite male sacrifice in redback spiders. *Behav. Ecol.* 9 (1), 33–42, Retrieved (<http://beheco.oxfordjournals.org/content/9/1/33abstract>).

Andrade, Maydianne C.B., 2003. Risky mate search and male self-sacrifice in redback spiders. *Behav. Ecol.* 14 (4), 531–538, Retrieved (<http://beheco.oxfordjournals.org/content/14/4/531abstract>).

Andrade, Maydianne C.B., Banta, Erin M., 2002. Value of male remating and functional sterility in redback spiders. *Anim. Behav.* 63 (5), 857–870, Retrieved (<http://www.sciencedirect.com/science/article/pii/S0003347202920038>).

Australian Museum n.d. 0000. ANIMAL SPECIES: Redback Spider, *Latrodectus Hasselti*. Retrieved (<http://australianmuseum.net.au/redback-spider>).

Baur, B., 1988. Population regulation in the land snail *arionta arbustorum*: Density effects on adult size, clutch size and incidence of egg cannibalism. *Oecologia* 77 (3), 390–394. <http://dx.doi.org/10.1007/BF00378049>, Retrieved.

Beddall, Barbara G., 1968. Wallace, darwin, and the theory of natural selection. *J. Hist. Biol.* 1 (2), 261–323.

Berning, Aric W., et al., 2012. Sexual cannibalism is associated with female behavioural type, hunger state and increased hatching success. *Anim. Behav.* 84 (3), 715–721, Retrieved (<http://www.sciencedirect.com/science/article/pii/S0003347212002916>).

Beyer, Hans-Georg, Schwefel, Hans-Paul, 2002. Evolution strategies—A comprehensive introduction. *Nat. Comput.* 1 (1), 3–52.

Birkhead, Tim R., Møller, Anders Pape, 1998. Sperm Competition and Sexual Selection. Academic Press.

Coello, Carlos A. Coello, 2000. Use of a self-adaptive penalty approach for engineering optimization problems. *Comput. Ind.* 41 (2), 113–127.

Coello, Carlos A. Coello, Montes, Efrén Mezura, 2002. Constraint-handling in genetic algorithms through the use of dominance-based tournament selection. *Adv. Eng. Inf.* 16 (3), 193–203.

Deb, Kalyanmoy, 1997. GeneAS: A robust optimal design technique for mechanical component design. In: *Evolutionary Algorithms in Engineering Applications*. Springer, pp. 497–514.

Derrac, Joaquín, García, Salvador, Molina, Daniel, Herrera, Francisco, 2011. A practical tutorial on the use of nonparametric statistical tests as a methodology for comparing evolutionary and swarm intelligence algorithms. *Swarm Evol. Comput.* 1 (1), 3–18.

Dhiman, Gaurav, Kumar, Vijay, 2017. Spotted hyena optimizer: A novel bio-inspired based metaheuristic technique for engineering applications. *Adv. Eng. Softw.* 114, 48–70.

Digalakis, Jason G., Margaritis, Konstantinos G., 2001. On benchmarking functions for genetic algorithms. *Int. J. Comput. Math.* 77 (4), 481–506.

Dong, Minggang, Wang, Ning, Cheng, Xiaohui, Jiang, Chuanxian, 2014. Composite differential evolution with modified oracle penalty method for constrained optimization problems. *Math. Probl. Eng.*

Dorigo, Marco, Maniezzo, Vittorio, Colomi, Alberto, 1996. Ant system: Optimization by a colony of cooperating agents. *IEEE Trans. Syst. Man Cybern. B* 26 (1), 29–41.

Downes, Michael F., 1986. Postembryonic development of *latrodectus hasselti* thorell (araneae, theridiidae). *J. Arachnol.* 14 (3), 293–301, Retrieved (<http://www.jstor.org/stable/3705670>).

Elgar, Mark A., Nash, David R., 1988. Sexual cannibalism in the garden spider *araneus diadematus*. *Anim. Behav.* 36 (5), 1511–1517, Retrieved (<http://www.sciencedirect.com/science/article/pii/S0003347288802215>).

ENGELHAUPT, ERIKA n.d. 0000. Some Animals Eat Their Moms, and Other Cannibalism Facts. *sciencenews*. Retrieved (<https://www.sciencenews.org/blog/gory-details/some-animals-eat-their-moms-and-other-cannibalism-facts>).

Erol, Osman K., Eksin, Ibrahim, 2006. A new optimization method: Big bang–big crunch. *Adv. Eng. Softw.* 37 (2), 106–111.

Foelix, R.F., 1996. *Biology of Spiders*. OUP USA/Georg Thieme Verlag. Retrieved (<https://books.google.com/books?id=XUgyqNKhyAC>).

Forster, L.M., 1992. The stereotyped behavior of sexual cannibalism in *latrodectus-hasselti* thorell (araneae, theridiidae), the Australian redback spider. *Aust. J. Zool.* 40 (1), 1–11, Retrieved (<http://www.publish.csiro.au/paper/ZO9920001>).

- Forster, L.M., 1995. The behavioural ecology of *latrodectus hasselti* (thorell), the australian redback spider (araneae: theridiidae): A review. *Rec. West. Aust. Mus. Suppl.* 52, 13–24.
- Fox, L.R., 1975. Cannibalism in natural populations. *Annu. Rev. Ecol. Syst.* 6 (1), 87–106. <http://dx.doi.org/10.1146/annurev.es.06.110175.000511>, Retrieved.
- Gage, Matthew J.G., 2005. Evolution: Sex and cannibalism in redback spiders. *Curr. Biol.* 15 (16), R630–R632, Retrieved (<http://www.sciencedirect.com/science/article/pii/S0960982205008626>).
- Garb, Jessica E., González, Alda, Gillespie, Rosemary G., 2004. The black widow spider genus *latrodectus* (araneae: theridiidae): Phylogeny, biogeography, and invasion history. *Mol. Phylogenetics Evol.* 31 (3), 1127–1142, Retrieved (<http://www.sciencedirect.com/science/article/pii/S1055790303003968>).
- Gaskett, A.C., 2007. Spider sex pheromones: Emission, reception, structures, and functions. *Biol. Rev.* 82 (1), 27–48. <http://dx.doi.org/10.1111/j.1469-185X.2006.00002.x>, Retrieved.
- Geem, Zong Woo, Kim, Joong Hoon, Loganathan, Gobichettipalayam Vasudevan, 2001. A new heuristic optimization algorithm: Harmony search. *Simulation* 76 (2), 60–68.
- Ghaemi, Manizheh, Feizi-Derakhshi, Mohammad-Reza, 2014. Forest optimization algorithm. *Expert Syst. Appl.* 41 (15), 6676–6687, Retrieved (<http://www.sciencedirect.com/science/article/pii/S0957417414002899>).
- Gray, M.R., n.d. 2007. 'Latrodectus Hasseltii (Family Theridiidae).' Department of Sustainability, Environment, Water, Population and Communities: Species Bank. Canberra, Australian Capital Territory: Australian Government. Retrieved (<http://www.environment.gov.au/cgi-bin/species-bank/sbank-treatment.pl?id=69198>).
- Guimaraes, Ingrid de Carvalho, da Silva, Herman Marques, Antoniali Junior, William Fernando, 2012. Aggregation behavior in spiderlings: A strategy for increasing life expectancy in *latrodectus geometricus* (araneae: theridiidae). *Sociobiology* 59 (2), 463–475.
- Hatamlou, Abdolreza, 2013. Black hole: A new heuristic optimization approach for data clustering. *Inform. Sci.* 222, 175–184.
- Hayyolalam, Vahideh, Pourhaji Kazem, Ali Asghar, 2018. A systematic literature review on qos-aware service composition and selection in cloud environment. *J. Netw. Comput. Appl.* 110, 52–74.
- He, Qie, Wang, Ling, 2007. An effective co-evolutionary particle swarm optimization for constrained engineering design problems. *Eng. Appl. Artif. Intell.* 20 (1), 89–99.
- Holland, John H., 1975. *Adaptation in Natural and Artificial Systems: An Introductory Analysis with Applications To Biology, Control, and Artificial Intelligence*. U Michigan Press.
- Jamil, Momin, Yang, Xin-She, 2013. A literature survey of benchmark functions for global optimisation problems. *Int. J. Math. Modelling Numer. Optim.* 4 (2), 150–194.
- Jayaweera, Anuradhi, Rathnayake, Darshana N., Davis, Kaytlyn S., Barry, Katherine L., 2015. The risk of sexual cannibalism and its effect on male approach and mating behaviour in a praying mantid. *Anim. Behav.* 110, 113–119, Retrieved (<http://www.sciencedirect.com/science/article/pii/S0003347215003528>).
- Kannan, B.K., Kramer, Steven N., 1994. An augmented lagrange multiplier based method for mixed integer discrete continuous optimization and its applications to mechanical design. *J. Mech. Des.* 116 (2), 405–411.
- Kaveh, A., Talatahari, S., 2010a. A novel heuristic optimization method: Charged system search. *Acta Mech.* 213 (3–4), 267–289.
- Kaveh, A., Talatahari, S., 2010b. An improved ant colony optimization for constrained engineering design problems. *Eng. Comput.* 27 (1), 155–182.
- Kirkpatrick, Scott, Daniel Gelatt, C., Vecchi, Mario P., 1983. Optimization by simulated annealing. *Science* 220 (4598), 671–680.
- Kumar, Vijay, Chhabra, Jitender Kumar, Kumar, Dinesh, 2014. Parameter adaptive harmony search algorithm for unimodal and multimodal optimization problems. *J. Comput. Sci.* 5 (2), 144–155.
- Li, L.J., Huang, Z.B., Liu, Feng, Wu, Q.H., 2007. A heuristic particle swarm optimizer for optimization of pin connected structures. *Comput. Struct.* 85 (7–8), 340–349.
- Liang, J.J., Qu, P.N., Suganthan, B.Y., Chen, Q., 2014. Problem Definitions and Evaluation Criteria for the CEC 2015 Competition on Learning-Based Real-Parameter Single Objective Optimization. Computational Intelligence Laboratory, Zhengzhou University, Zhengzhou China and Technical Report, Nanyang Technological University, Singapore, Technical Report201411A.
- Liang, Jane-Jing, Suganthan, Ponnuthurai Nagaratnam, Deb, Kalyanmoy, 2005. Novel Composition Test Functions for Numerical Global Optimization, In: *Swarm Intelligence Symposium, 2005. SIS 2005. Proceedings 2005 IEEE*, pp. 68–75.
- Lin, Lin, Gen, Mitsuo, 2009. Auto-tuning strategy for evolutionary algorithms: Balancing between exploration and exploitation. *Soft Comput.* 13 (2), 157–168.
- Lu, Xueyan, Zhou, Yongquan, 2008. A Novel Global Convergence Algorithm: Bee Collecting Pollen Algorithm, In: *International Conference on Intelligent Computing*, pp. 518–525.
- Mahdavi, M., Fesanghary, Mohammad, Damangir, E., 2007. An improved harmony search algorithm for solving optimization problems. *Appl. Math. Comput.* 188 (2), 1567–1579.
- McKeown, Keith C., 1963. *Australian Spiders*. Sirius Books, Angus and Robertson.
- Mezura-Montes, Efrén, Coello Coello, Carlos A., 2008. An empirical study about the usefulness of evolution strategies to solve constrained optimization problems. *Int. J. Gen. Syst.* 37 (4), 443–473.
- Mirjalili, Seyedali, 2015a. Moth-flame optimization algorithm: A novel nature-inspired heuristic paradigm. *Knowl.-Based Syst.* 89, 228–249.
- Mirjalili, Seyedali, 2015b. The ant lion optimizer. *Adv. Eng. Softw.* 83, 80–98.
- Mirjalili, Seyedali, Lewis, Andrew, 2013. S-shaped versus v-shaped transfer functions for binary particle swarm optimization. *Swarm Evol. Comput.* 9, 1–14.
- Mirjalili, Seyedali, Lewis, Andrew, 2016. The whale optimization algorithm. *Adv. Eng. Softw.* 95, 51–67.
- Mirjalili, Seyedali, Mirjalili, Seyed Mohammad, Hatamlou, Abdolreza, 2016. Multi-verse optimizer: A nature-inspired algorithm for global optimization. *Neural Comput. Appl.* 27 (2), 495–513.
- Mirjalili, Seyedali, Mirjalili, Seyed Mohammad, Lewis, Andrew, 2014a. Grey wolf optimizer. *Adv. Eng. Softw.* 69, 46–61.
- Mirjalili, Seyedali, Mirjalili, Seyed Mohammad, Yang, Xin-She, 2014b. Binary bat algorithm. *Neural Comput. Appl.* 25 (3–4), 663–681.
- Mock, Douglas W., Ploger, Bonnie J., 1987. Parental manipulation of optimal hatch asynchrony in cattle egrets: An experimental study. *Anim. Behav.* 35 (1), 150–160, Retrieved (<http://www.sciencedirect.com/science/article/pii/S0003347287802208>).
- Modanu, Maria, Xuan Li, Lucy Dong, Said, Hosay, Rathitharan, Nizanthan, Andrade, Maydianne C.B., 2014. Sibling cannibalism in a web-building spider: Effects of density and shared environment. *Behav. Process.* 106, 12–16, Retrieved (<http://www.sciencedirect.com/science/article/pii/S0376635714000837>).
- Molga, M., Smutnicki, C., 2005. Test Functions for Optimization Needs. *Test Functions for Optimization Needs*.
- Perampaladas, Kuhan, Stoltz, J.A., Andrade, M.C.B., 2008. Mated redback spider females re-advertise receptivity months after mating. *Ethology* 114 (6), 589–598. <http://dx.doi.org/10.1111/j.1439-0310.2008.01513.x>, Retrieved.
- Perry, J.C., Roitberg, B.D., 2005. Games among cannibals: Competition to cannibalize and parent-offspring conflict lead to increased sibling cannibalism. *J. Evol. Biol.* 18 (6), 1523–1533. <http://dx.doi.org/10.1111/j.1420-9101.2005.00941.x>, Retrieved.
- Petersen, Anja, Nielsen, Kristian T., Christensen, Christian B., Toft, S'ren, 2010. The advantage of starving: Success in cannibalistic encounters among wolf spiders. *Behav. Ecol.* 21 (5), 1112–1117, Retrieved (<http://beheco.oxfordjournals.org/content/21/5/1112.abstract>).
- Poli, Riccardo, Kennedy, James, Blackwell, Tim, 2007. Particle swarm optimization. *Swarm Intell.* 1 (1), 33–57.
- Pourghebileh, Behrouz, Hayyolalam, Vahideh, 2019. A comprehensive and systematic review of the load balancing mechanisms in the internet of things. *Cluster Comput.* 1–21.
- Pourghebileh, Behrouz, Navimipour, Nima Jafari, 2017. Data aggregation mechanisms in the internet of things: A systematic review of the literature and recommendations for future research. *J. Netw. Comput. Appl.*
- Qu, B.Y., Liang, Z.Y., Wang, Q., Chen, J.J., Suganthan, P.N., 2016. Novel benchmark functions for continuous multimodal optimization with comparative results. *Swarm Evol. Comput.* 26, 23–34.
- Rashedi, Esmat, Nezamabadi-pour, Hossein, Saryazdi, Saeid, 2009. GSA: A gravitational search algorithm. *Inform. Sci.* 179 (13), 2232–2248, Retrieved (<http://www.sciencedirect.com/science/article/pii/S0020025509001200>).
- Sandgren, E., 1990. Nonlinear integer and discrete programming in mechanical design optimization. *J. Mech. Des.* 112 (2), 223–229.
- Schausberger, P., Hoffmann, D., 2008. Maternal manipulation of hatching asynchrony limits sibling cannibalism in the predatory mite *phytoseius persimilis*. *J. Anim. Ecol.* 77 (6), 1109–1114. <http://dx.doi.org/10.1111/j.1365-2656.2008.01440.x>, Retrieved.
- Scott, Catherine, Kirk, Devin, McCann, Sean, Gries, Gerhard, 2015. Web reduction by courting male black widows renders pheromone-emitting females' webs less attractive to rival males. *Anim. Behav.* 107, 71–78, Retrieved July 16, 2015 (<http://www.sciencedirect.com/science/article/pii/S0003347215002262>).
- Sebastian, P.A., Peter, K.V., 2009. *Spiders of India*. Universities Press, India, Retrieved (<https://books.google.com/books?id=9oVHO-3ZGx4C>).
- Shah-Hosseini, Hamed, 2011. Principal components analysis by the galaxy-based search algorithm: A novel metaheuristic for continuous optimisation. *Int. J. Comput. Sci. Eng.* 6 (1–2), 132–140.
- Shiqin, Yang, Jianjun, Jiang, Guangxing, Yan, 2009. A Dolphin Partner Optimization, In: *2009 WRI Global Congress on Intelligent Systems, Vol. 1*, pp. 124–28.
- Simon, Dan, 2008. Biogeography-based optimization. *IEEE Trans. Evol. Comput.* 12 (6), 702–713.
- Suganthan, Ponnuthurai N., et al., 2005. Problem Definitions and Evaluation Criteria for the CEC 2005 Special Session on Real-Parameter Optimization. *KanGAL report 2005005:2005*.
- Wang, Daobin, et al., 2011. Slow light engineering in polyatomic photonic crystal waveguides based on square lattice. *Opt. Commun.* 284 (24), 5829–5832.

- Watson, P.J., 1986. Transmission of a female sex pheromone thwarted by males in the spider *linyphia litigiosa* (linyphiidae). *Science* 233 (4760), 219–221, Retrieved (<http://science.sciencemag.org/content/233/4760/219>).
- Wikipedia. n.d. 0000. Black Widow. Retrieved (<https://en.wikipedia.org/wiki/Latrodectus>).
- Wikipedia. 2016. Redback Spider — Wikipedia{, } The Free Encyclopedia. Retrieved (https://en.wikipedia.org/w/index.php?title=Redback_spider&oldid=723832167).
- Wolpert, David H., Macready, William G., et al., 1997. No free lunch theorems for optimization. *IEEE Trans. Evol. Comput.* 1 (1), 67–82.
- Yang, Xin-She, 2010a. Firefly Algorithm, Stochastic Test Functions and Design Optimisation. arXiv preprint [arXiv:1003.1409](https://arxiv.org/abs/1003.1409).
- Yang, Xin-She, 2010b. Test Problems in Optimization. arXiv preprint [arXiv:1008.0549](https://arxiv.org/abs/1008.0549).
- Yang, Xin-She, Deb, Suash, 2009. Cuckoo Search via Lévy Flights, In: 2009 World Congress on Nature & Biologically Inspired Computing (NaBIC), pp. 210–14.
- Yang, Chenguang, Tu, Xuyan, Chen, Jie, 2007. Algorithm of Marriage in Honey Bees Optimization Based on the Wolf Pack Search, In: The 2007 International Conference on Intelligent Pervasive Computing (IPC 2007), pp. 462–67.
- Yao, Xin, Liu, Yong, Lin, Guangming, 1999. Evolutionary programming made faster. *IEEE Trans. Evol. Comput.* 3 (2), 82–102.